

*corrateg*  
PASSION OF CYCLING

**ORIGINAL INSTRUCTION MANUAL**

ROAD/MTB/TREKKING/KID

## 1 Greeting

### **Dear Customer,**

We thank you for purchasing this bike and for the trust you have placed in us. You've made an excellent choice: The functions on your bike comply with the latest state of technology.

You are getting an extremely dependable and safe bike: our frames are tested in accordance with DIN EN 4210 and DIN EN 82079-1, and all corratec bicycles are completely assembled in Germany. Our professional teams also constantly put frames and components to the test under strict competitive conditions.

This user manual provides you with everything you need to know about your new bike: Basic knowledge of the individual components, instructions on the most important maintenance and servicing activities for domestic use as well as hints and tips on making work easier and on the topic of safety.

Maintenance work requiring expert knowledge and expensive special tools should be performed by your specialist dealer. Keep in close contact with your specialist dealer in order to always be able to refer to an expert workshop for upcoming inspections. Your specialist dealer can recognise signs of wear or minor technical imperfections at an early stage.

Please also pay particular attention to the notes provided on adjusting the bike to your individual needs so that you can sit comfortably on your new bike and ride efficiently.

And one more thing: From now on, carrying out a small safety check before every ride should become routine.

Happy cycling!

**Your corratec Team**

## 2 City bike components



This illustration may vary depending on the bicycle model or equipment selected. Read the special instructions for your equipment in the corresponding sections.

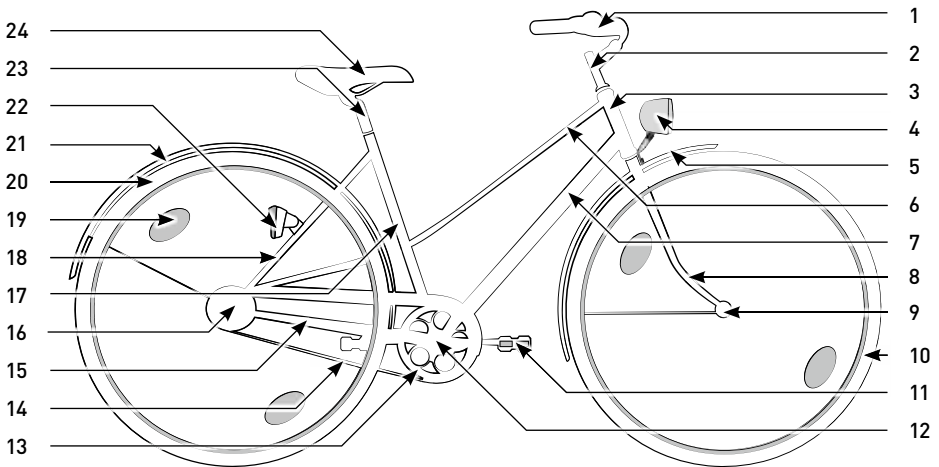

- |                      |                          |
|----------------------|--------------------------|
| 1 Handlebar          | 13 Chain wheel           |
| 2 Handlebar stem     | 14 Chain                 |
| 3 Steering head tube | 15 Bottom chainstay tube |
| 4 Headlamp           | 16 Rear wheel hub        |
| 5 Front mudguard     | 17 Seat tube             |
| 6 Top tube           | 18 Top chainstay strut   |
| 7 Bottom tube        | 19 Side reflector        |
| 8 Fork               | 20 Rear wheel            |
| 9 Front wheel hub    | 21 Rear mudguard         |
| 10 Front wheel       | 22 Tail lamp             |
| 11 Pedal             | 23 Seatpost              |
| 12 Bottom bracket    | 24 Saddle                |

### 3 MTB bicycle components

**i** This illustration may vary depending on the bicycle model or equipment selected. Read the special instructions for your equipment in the corresponding sections.

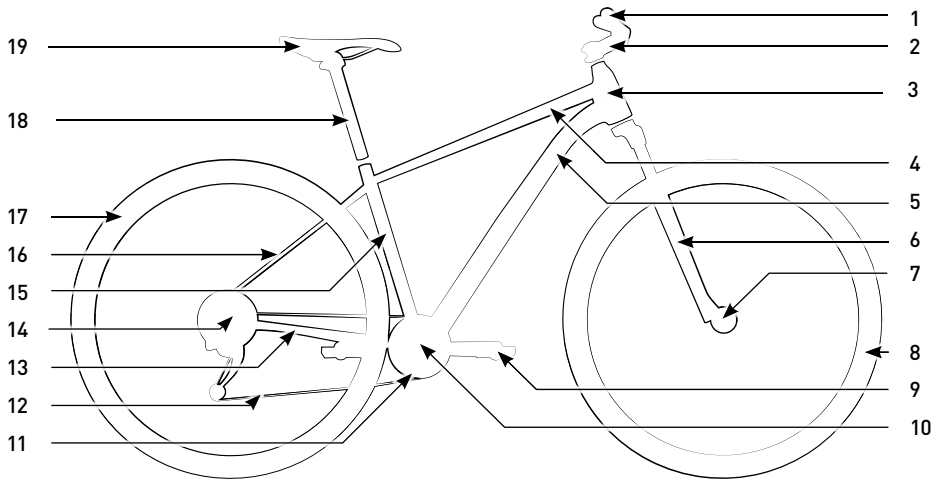

- |                      |                          |
|----------------------|--------------------------|
| 1 Handlebar          | 11 Chain wheel           |
| 2 Handlebar stem     | 12 Chain                 |
| 3 Steering head tube | 13 Bottom chainstay tube |
| 4 Top tube           | 14 Rear wheel hub        |
| 5 Bottom tube        | 15 Seat tube             |
| 6 Fork               | 16 Top chainstay strut   |
| 7 Front wheel hub    | 17 Rear wheel            |
| 8 Front wheel        | 18 Seatpost              |
| 9 Pedal              | 19 Saddle                |
| 10 Bottom bracket    |                          |



## 4 Racing bike components



This illustration may vary depending on the bicycle model or equipment selected. Read the special instructions for your equipment in the corresponding sections.

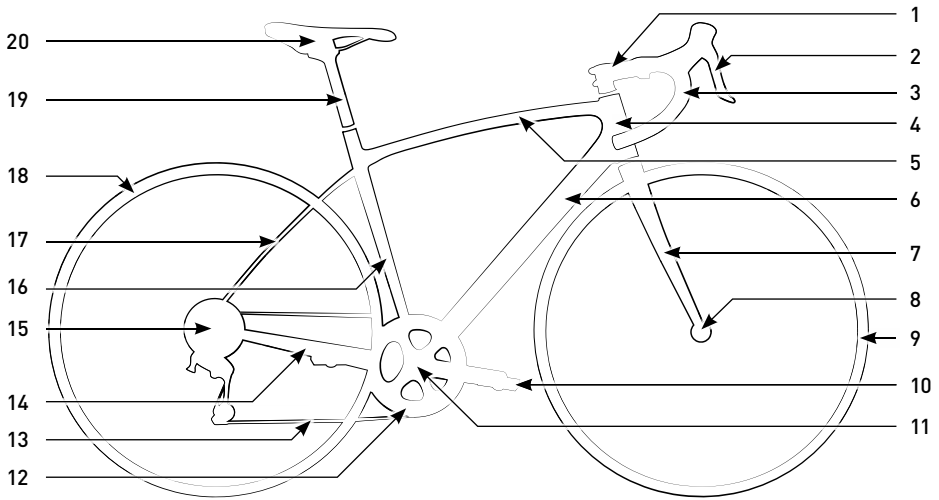

- 1 Handlebar stem
- 2 Brake shift lever
- 3 Handlebar
- 4 Steering head tube
- 5 Top tube
- 6 Bottom tube
- 7 Fork
- 8 Front wheel hub
- 9 Front wheel
- 10 Pedal

- 11 Bottom bracket
- 12 Chain wheel
- 13 Chain
- 14 Bottom chainstay tube
- 15 Rear wheel hub
- 16 Seat tube
- 17 Top chainstay strut
- 18 Rear wheel
- 19 Seatpost
- 20 Saddle

1 Greeting. . . . .	2
2 City bike components. . . . .	3
3 MTB bicycle components . . . . .	4
4 Racing bike components . . . . .	5
5 Basics . . . . .	13
5.1 Reading and storing the instruction manual. . . . .	13
5.2 Warning information . . . . .	13
5.3 Signs and symbols. . . . .	14
5.4 Units and their meaning . . . . .	14
5.5 Intended use. . . . .	15
5.6 Bicycle categories . . . . .	16
5.7 Maximum permitted total weight. . . . .	16
5.8 Information on torque values . . . . .	16
5.9 Rotation direction of screws. . . . .	17
5.10 Seating position . . . . .	18
5.11 Transport. . . . .	19
5.12 After a fall or accident . . . . .	19
5.13 Wear. . . . .	20
6 Safety. . . . .	21
6.1 Instructions for safe use . . . . .	21
6.2 General safety information. . . . .	21
6.3 Road safety. . . . .	22
6.3.1 Handlebar extensions . . . . .	23
6.3.2 Additional regulations. . . . .	24
6.3.3 Riding with children . . . . .	24
6.4 Replacing bicycle components. . . . .	26

6.5 Residual risks . . . . .	27
7 Basic adjustments . . . . .	28
7.1 Before your first trip . . . . .	28
7.2 Checks before each journey . . . . .	28
7.3 Adjusting the seat position . . . . .	30
7.4 Observe the rotation direction of screws . . . . .	31
7.5 Observing the torque values . . . . .	31
8 Brakes . . . . .	32
8.1 Inspecting the brakes . . . . .	33
8.2 Brake lever assignment . . . . .	33
8.3 Rim brake . . . . .	34
8.3.1 Rim brake with quick-release fastener . . . . .	34
8.3.2 Basics . . . . .	35
8.3.3 Checking the brake linings . . . . .	35
8.4 Operating the rim brakes . . . . .	36
8.5 Adjusting the rim brakes . . . . .	37
8.5.1 Adjusting the grip range . . . . .	37
8.5.2 Adjusting the brake cable . . . . .	37
8.6 Disc brake . . . . .	39
8.6.1 Basics . . . . .	39
8.6.2 Operating the disc brake . . . . .	41
8.6.3 Adjusting the disc brake . . . . .	41
8.6.4 Replacing the brake linings . . . . .	41
9 Coaster brake . . . . .	42
9.1 Basics . . . . .	42
9.2 Operating the coaster brake . . . . .	43

9.3 Adjusting the coaster brake .....	43
10 Roller brake .....	44
10.1 Basics .....	44
10.2 Operating the roller brake .....	44
10.3 Adjusting the roller brake .....	44
11 Drum brake .....	46
11.1 Basics .....	46
11.2 Operating the drum brake .....	46
11.3 Adjusting the drum brake .....	46
12 Drives .....	48
12.1 Pedal drive .....	48
12.1.1 Basics .....	48
12.1.2 Operating the pedal drive .....	48
12.1.3 Checking the pedal drive .....	48
12.2 Chain drive .....	49
12.2.1 Basics .....	49
12.2.2 Operating the chain drive .....	49
12.2.3 Adjusting the chain drive .....	49
12.3 Belt drive .....	50
12.3.1 Basics .....	50
12.3.2 Operating the belt drive .....	51
12.3.3 Adjusting the belt drive .....	51
13 Gear shifting system .....	53
13.1 Operating elements .....	53
13.2 Derailleur gear .....	54
13.2.1 Basics .....	54
13.2.2 Operating the derailleur gear .....	56
13.2.3 Adjusting the derailleur gear .....	57

13.3 Hub shifting system . . . . .	59
13.3.1 Basics . . . . .	59
13.3.2 Operating the hub shifting system . . . . .	60
13.3.3 Adjusting the hub shifting system . . . . .	60
13.4 Hybrid shifting system . . . . .	63
13.4.1 Basics . . . . .	63
13.4.2 Operating the hybrid shifting system . . . . .	63
13.4.3 Adjusting the hybrid shifting system . . . . .	63
13.5 Continuously variable shifting system. . . . .	64
13.5.1 Basics . . . . .	64
13.5.2 Operating the continuously variable shifting system . . . . .	64
13.5.3 Adjusting the variable shifting system . . . . .	65
13.6 Continuously variable automatic gear shifting system . . . . .	65
13.6.1 Basics . . . . .	65
13.6.2 Operating the continuously variable automatic gear shifting system . . . . .	66
13.6.3 Adjusting the continuously variable automatic gear shifting system . . . . .	67
14 Lighting . . . . .	68
14.1 Basics . . . . .	68
14.2 Operating lamps . . . . .	69
14.2.1 Bottle dynamo . . . . .	69
14.2.2 Hub dynamo . . . . .	70
14.3 Adjusting the light . . . . .	70
14.3.1 Aligning the bracket. . . . .	70
14.3.2 Aligning the headlamp . . . . .	71
15 Wheels and tyres . . . . .	72
15.1 Basics . . . . .	72
15.1.1 Rims and spokes. . . . .	72
15.1.2 Wear limit . . . . .	72
15.2 Adjustments . . . . .	73
15.2.1 Checking and adjusting spokes . . . . .	73

15.2.2	Checking the wear limit or replacing the rim .....	73
16	Tyres and valves .....	73
16.1	Basics .....	73
16.1.1	Valve types.....	74
16.1.2	Tyre inflation pressure .....	75
16.2	Adjustments .....	76
17	Other components .....	77
17.1	Handlebar .....	77
17.1.1	Basics.....	77
17.1.2	Using the handlebar.....	77
17.1.3	Adjustments: Handlebar height .....	77
17.1.4	Adjustments: Handlebar position.....	78
17.1.5	Adjusting the steering head bearing .....	80
17.1.6	Racing bike handlebars .....	80
17.2	Saddle .....	80
17.2.1	Basics .....	80
17.2.2	Adjusting the saddle .....	80
17.3	Pedals .....	82
17.3.1	Basics .....	82
17.3.2	Using the pedals.....	82
17.3.3	Fitting pedals .....	82
17.4	Luggage rack .....	83
17.4.1	Basics .....	83
17.4.2	Using your luggage carrier.....	84
17.5	Luggage.....	84
17.6	Bell.....	85
17.6.1	Basics.....	85
17.6.2	Operating the bell .....	85
17.6.3	Adjusting the bell.....	85
17.7	Kickstand.....	85

17.7.1 Basics	85
17.7.2 Operating the kickstand	85
17.7.3 Adjusting the kickstand	85
17.8 Frame lock	86
17.8.1 Closing the frame lock	86
17.8.2 Opening the frame lock	86
17.9 Suspension	87
17.9.1 Suspension fork	87
17.9.2 Chainstay frame damper	91
17.9.3 Coil-sprung seatpost	92
17.10 Quick-releases	94
17.10.1 Basics	94
17.10.2 Operating quick-releases	94
17.10.3 Adjusting quick-releases	95
18 Storage and disposal	96
18.1 Storing the bicycle	96
18.2 Cleaning the bicycle	96
18.3 Disposal	97
18.3.1 Disposing of packaging	97
18.3.2 Disposing of lubricants and care products	97
18.3.3 Disposing of tyres and inner tubes	97
18.3.4 Disposing of the bicycle	97
19 Warranty and guarantee terms and conditions	98
19.1 General	98
19.2 Guarantee terms and conditions	98
20 Bike passport	99
21 Handover certificate	100
22 Inspection report	101

<b>CHILDREN'S BIKE</b>	<b>102</b>
23 General information . . . . .	103
24 Safety information . . . . .	104
25 Residual risks . . . . .	106
26 Proper use . . . . .	107
27 Basics . . . . .	107
27.1 Information on road use . . . . .	107
27.2 Rules for children up to 10 years of age in Germany . . . . .	109
27.3 Notes on brakes . . . . .	109
27.4 Before each ride . . . . .	109
27.5 Inspection instructions . . . . .	109
27.6 Before your first trip . . . . .	110
28 Stabilisers . . . . .	111
28.1 Fitting stabilisers . . . . .	111
28.2 Removing stabilisers . . . . .	112
29 Publisher . . . . .	113



## 5 Basics

### 5.1 Reading and storing the instruction manual



This instruction manual belongs to the bicycle. The user manual contains important information on adjusting and using the bicycle. Before using the bicycle, read through all the warnings and information in this user manual carefully, in particular the section entitled "Safety". Ignoring the warnings and information in this instruction manual can result in serious personal injury and damage to the bicycle. Keep the instruction manual close at hand so you have easy access to it at all times. If you sell or give the bicycle to another person, hand over the instruction manual as well.

### 5.2 Warning information

The purpose of warning information is to draw your attention to potential dangers. Warning information requires your full attention and understanding of the statements provided. Ignoring a warning can result in injury to yourself or others. The warnings themselves do not prevent dangers. Follow all warning notes to avoid risks when using the bicycle.

The warnings in this user manual have the following meanings:



#### **WARNING**

The signal word denotes a medium risk that can cause death or a serious injury if not avoided.





#### **CAUTION**

The signal word denotes a low risk that can cause a slight or minor injury if not avoided.

#### **NOTE**

The signal word warns of possible material damage.

### 5.3 Signs and symbols

	Always read the instruction manual all the way through.
	Additional instructions for handling or use.
1.	Handling instructions that must be performed in a specific order start with a number.
→	Handling instructions that can be performed in any order start with an arrow.
•	List items start with a bullet point.

### 5.4 Units and their meaning

You will find the following units in this user manual or on your bicycle's components:

Unit	Meaning	Unit for
°	Degree	Angle
°C	Degree Celsius	Temperature
°F	Degree Fahrenheit	Temperature (USA)
1/s	Per second	Revolutions
"	Inch	Unit of length (USA) 1 inch = 2.54 cm
bar	Bar	Pressure
g	Gram	Mass (Weight)
h	Hour	Time
Hz	Hertz	Frequency
kg	Kilogram	Mass (Weight)
km/h	Kilometre per hour	Speed
kPa	Kilopascal	Pressure
mph	Miles per hour	Speed
Nm	Newton metre	Torque
psi	Pound per square inch	Pressure (USA)

## 5.5 Intended use

The manufacturer or bicycle dealer does not accept liability for damage resulting from improper use. Always use the bicycle as described in the instruction manual. Any other use is considered improper and may result in accidents, serious injury and damage to the bicycle.

Improper use of the bicycle will void the warranty.

Upgrading bicycles to a pedelec or S-pedelec is not permitted.

Manipulating the drive unit on pedelecs and S-pedelecs is prohibited. Improper use of the bicycle will void the warranty (see section „Warranty and guarantee terms and conditions“ on page 98).

The bicycle was designed to be used by one person for whom the seating position has been set accordingly. The bike is intended solely for private use.

The bike is only designed for use on roads and paths with a smooth surface. Riding on unpaved roads, which are not asphalted, made of concrete or paved, may result in the failure of the bicycle.

Refer to the “Bicycle categories” section to determine which surfaces your bicycle is suitable for. Riding on surfaces other than those specified may cause the bicycle to fail.

The bicycle is not intended to be subjected to above-average strain during use, e.g. the use of the bicycle in racing or competitive events is not considered to be in accordance with its intended use.

In order to use your bicycle properly on the road, you must be aware of, understand and adhere to the relevant national and regional regulations.

The use of child seats, child trailers and other bicycle trailers (cargo and dog trailers) is only permitted for category 2 and 3 bicycles (see section „Bicycle categories“ on page 16).

Exceptions include:

- Bicycles with carbon frame
- S-pedelec type bicycles
- Children’s and kid’s bicycles with wheel sizes of 12“, 16“, 20“ and 24“.

Racing and fitness bikes are only designed for use on roads and paths with a smooth asphalted, concreted or paved surface. Riding on unpaved roads can cause the bicycle to break. Fitting a luggage rack, child seat or bike trailer is permitted only if this use is included in the bike passport (see section „Bike passport“ on page 99).

A racing/fitness bike is defined as a bicycle

- with a racing handlebar (racing bike) or a flat handlebar (flatbar on fitness bike),
- with road tyres up to 32 mm in width,
- with a rigid frame,
- that requires the rider to adopt a sporty, stretched seating position.

## 5.6 Bicycle categories

The user manual contains important information on adjusting and using

- bicycles and
- children's cycles.

The user manual for children's cycles is a separate section (see section „Children's bike“ on page 102).

## 5.7 Maximum permitted total weight

The bicycle has a maximum permitted total weight that must be observed when using the bicycle.

→ Determine the empty weight of your bicycle using suspended scales, if necessary with all items of optional equipment attached.

The maximum permitted total weight is calculated by adding the following weight specifications:

Bicycle + rider + luggage/child seat, etc. = maximum permitted total weight.

→ If you always observe the maximum permitted total weight of the bicycle, you will reduce the risk of having an accident, suffering an injury and damaging the bicycle. Failure to observe the total weight specification can lead to warranty and guarantee exclusions.

## 5.8 Information on torque values



### WARNING

Tightening screw connections incorrectly can cause material fatigue.

#### **Risk of accident and injury!**

- ▶ If the screw connections are loose, do not use the bicycle.
- ▶ Tighten the screw connections with the correct torque values.

Observe the relevant torque values to ensure the screw connections are tightened correctly. A torque wrench with a suitable adjustment range is required for this.

→ If you do not have any experience working with torque wrenches or do not have access to a suitable torque wrench, have the screw connections checked by a bicycle dealer.

The correct torque value for a screw connection depends on the material and diameter of the screw as well as the material and design of the component.

→ If you tighten screw connections yourself, check whether your bike is equipped with aluminium or carbon components (see the datasheet containing the technical data provided by the bicycle dealer).

→ Observe the special torque values for components manufactured from aluminium or carbon.

→ Torque specifications and markings specifying the insertion depth are indicated on individual bicycle components. Always observe these specifications and markings.

Not all components are listed in this table.

The torque specifications are basic values.

→ You can request the relevant torque values for other components if necessary, or read the user manual accompanying the components.

Screw connection	Torque in Nm
Crank (steel/aluminium)	30/40
Pedal, size 15	30
Front/rear axle nuts (15 mm)	25/35
Saddle (adjusting screw) M6/M8	14/20
Seatpost clamp M5/M6	5/10
Brake and shift levers on the handlebar	3
Handlebar stem with inner clamping (shaft stem clamping spindle)	8
Handlebar stem with outer clamping (shaft clamping/handlebar clamping)	4/5

## 5.9 Rotation direction of screws

→ Turn in the screws, quick-release axles and nuts in a clockwise direction and tighten.

 If the rotation direction deviates from this rule, it will be indicated in the respective section. Observe the relevant instructions.

## 5.10 Seating position



### CAUTION

An incorrect seating position can cause muscle tension and joint pain.

#### Risk of injury!

► Have your seating position set correctly by a bicycle dealer.

---



### CAUTION

An incorrect seating position makes the operating elements on the handlebar more difficult to reach.

#### Risk of accident and injury!

► Have your seating position set correctly by a bicycle dealer.

---

In order for you to control the bicycle safely, the seating position must be adapted to your individual needs.

The ideal seating position depends on the frame size and geometry of the bicycle, the height of the rider, as well as the handlebar and saddle settings. Specialist know-how is required to achieve the best seating position. The best seating position may also depend on how the bicycle will be used, e.g. predominantly for sport.

The key characteristics of an appropriate seating position are:

- If a pedal is at the top, the knee angle of the upper leg and the arm angle is  $90^\circ$ . The lower leg must be slightly bent (see Fig. 'Characteristics of an appropriate seating position', left).
- When one pedal is forwards, the knee must be above the axle of the front pedal (see Fig. 'Characteristics of an appropriate seating position', right).
- The arms must be relaxed and bent outwards slightly (not shown in the illustration).
- The back is not vertical in relation to the seatpost.

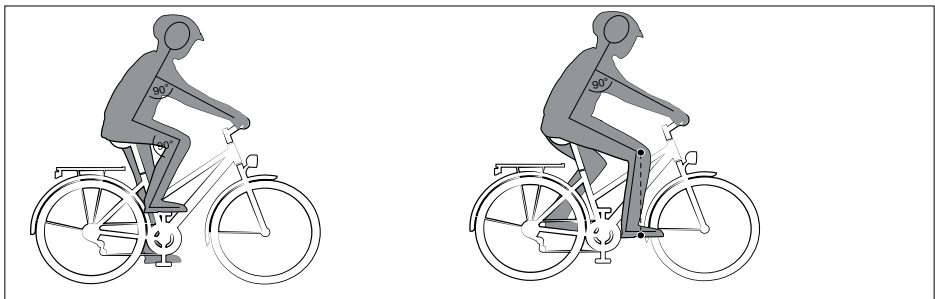

Fig. Characteristics of an appropriate seating position

## 5.11 Transport

### NOTE

Incorrect use of bicycle racks can result in material damage.

#### **Risk of damage!**

- ▶ Always use approved bicycle racks to transport the bicycle upright.
- ▶ Have the bicycle dealer inform you about how to use bicycle racks.
- ▶ Secure the bicycle to prevent it from slipping or falling over.

A transport lock for the disc brake may be included in the delivery, depending on the model.

- Ask a bicycle dealer to explain how to use a transport lock.
- Use the transport restraint when transporting the bicycle.
- Transport the bicycle in an upright position.

## 5.12 After a fall or accident



### WARNING

Falls or accidents can cause damage to the bicycle, such as hairline cracks. Components may be damaged but the damage may not be visible.

#### **Risk of accident and injury!**

- ▶ After a fall or accident, ask a bicycle dealer to inspect the bicycle for damage.
- ▶ Do not straighten damaged components.
- ▶ Have a bicycle dealer replace damaged components immediately.
- ▶ Do not use the bicycle if damage to the bicycle is visible or suspected.

A fall or accident may damage components. Damage to carbon components is not always visible. Fibres or paint may come off or be damaged beyond repair and the strength of the components may be reduced as a result.

- Have a bicycle dealer replace any carbon components damaged during a fall or accident.
- After a minor fall, e.g. if the bicycle falls over by itself, check all the components on the bicycle.
- If in doubt or if repairs are needed, consult a bicycle dealer.

## 5.13 Wear



### **WARNING**

Excessive wear, material fatigue or loose screw connections can cause functional impairments that may lead to accidents or falls.

#### **Risk of accident and injury!**

- ▶ Regularly inspect the bicycle for wear.
  - ▶ Do not use the bike if there are deformations, cracks and changes in colour.
  - ▶ Do not use the bike if there is excessive wear or loose screw connections.
  - ▶ If you discover any excessive wear, loose screw connections, cracks, deformations or discolouration, have the bicycle inspected immediately by a bicycle dealer.
- 

Like all mechanical components, the bicycle is subject to wear and high loads. Different materials react to wear or abrasion caused by stress in different ways. Any type of crack, scratch or discolouration indicates that the useful life of the component is coming to an end. Worn components must be replaced.

Only a bicycle dealer can assess the wear on components made from aluminium, carbon or composite materials. Components made of composite material are sensitive to high temperatures (e.g. radiant heat) and can be damaged if exposed to them.

Heavy impacts, bumps and distortion are detrimental to frames, forks and wheels made of carbon and composite materials. This has a detrimental effect on the internal structure of the material without this being outwardly visible.

- Ask a bicycle dealer for advice about the wear components on your bicycle.
- Check the condition of all wear parts at regular intervals.
- Maintain all wear parts regularly.



## 6 Safety

This section contains information on how to use your bicycle safely.

### 6.1 Instructions for safe use

Observe the following information on safe use of your bicycle to reduce the risk of you having an accident or sustaining an injury:

- Please use the bicycle only if you are fully acquainted with the operation of the bicycle and all of its functions.
- Always use the bicycle as described in the section on intended use.
- Do not allow persons with reduced physical, sensory or mental abilities or a lack of experience or knowledge to use the bicycle.
- Do not allow children to play with the bicycle.
- Do not allow children to clean, maintain or service the bicycle.
- If you do not have the necessary know-how and tools to make adjustments and repairs, have a bicycle dealer perform them.

### 6.2 General safety information

In the interests of your own safety, please note the following safety information:



#### **WARNING**

Wet, slippery or dirty roads can increase the braking distance or impair the road holding of your bicycle.

#### **Risk of accident and injury!**

► Adapt your riding style and speed to the weather and road conditions.



#### **CAUTION**

Flat shoes can easily slip from the pedals.

#### **Risk of injury!**

► Wear shoes with a slip-resistant sole.



#### **CAUTION**

Using a bicycle rest handlebar or aero bar restricts the range of the operating elements and increases the overall stopping distance.

#### **Risk of injury!**

► Ride with care and adapt your riding style accordingly.



## CAUTION

Items of clothing and body parts may become entangled in moving parts on the bicycle.

### **Risk of injury!**

- ▶ Do not allow loose straps or cords such as shoelaces or jacket straps to hang down.
  - ▶ Wear close-fitting clothing or use bicycle clips.
  - ▶ Before cleaning or maintenance, identify all moving parts of the bicycle.
- 

## NOTE

Using your bicycle incorrectly or improperly can cause certain bicycle components to wear more quickly or even break.

### **Risk of damage!**

- ▶ Do not ride over steps or other types of ledges.
  - ▶ Do not use your bicycle to jump over ramps or mounds of earth.
  - ▶ Do not ride your bike on fast downhill gradients.
  - ▶ Do not ride your bicycle through deep water.
  - ▶ Observe the maximum permitted total weight of the bicycle.
  - ▶ Observe the tyre inflation pressure.
- 

## 6.3 Road safety

Observe the following general safety information to increase overall levels of safety when riding your bicycle on the road:

- Only use your bicycle on the road if the equipment fitted meets the road traffic regulations applicable in your country.
- Observe and respect all national and regional road traffic regulations.
- Always ride your bicycle wearing a suitable bicycle helmet that has been certified according to standard DIN EN 1078 and bears the CE mark.
- Wear bright clothing with reflective elements while riding.
- Never use your bicycle under the influence of alcohol, intoxicants or medication that may affect your judgement.
- Do not operate mobile devices such as smartphones or MP3 players while riding.
- Do not allow yourself to be distracted by other activities during your journey, such as switching on your lights.
- Always ride your bicycle with both hands on the handlebar at all times.

 Please note that road traffic also includes private land, forest paths and dirt roads when they are publicly accessible.

Increase your overall safety on the roads by also observing the following instructions:

- For more information about the road traffic regulations currently applicable in your country or region, contact an organisation such as the Department of Transport.
- Ensure that you regularly obtain information regarding changes to the content of the regulations in force.
- Ride carefully and with consideration for other road users.
- Ride in such a way that nobody suffers injury, is endangered, incapacitated or disturbed.
- Always use lanes and paths reserved specifically for bicycles.

### 6.3.1 Handlebar extensions



#### **WARNING**

Increased stopping distance due to longer cable travel from the brake levers.

#### **Risk of accident and injury!**

- ▶ Familiarise yourself with the handlebar extensions and how to reach for the brake levers.
- ▶ Ride with particular care when using handlebar extensions.

#### 6.3.1.1 Bar ends

Using bar ends in road traffic is associated with risk. Your hands will have to move too far to reach the brake levers, which can result in accidents in hazardous situations.

Bar ends are extra grips at the ends of the handlebar which can enable the rider to adopt a better posture during particularly steep climbs.

#### 6.3.1.2 Triathlon handlebar extension kit

To allow the rider to adopt an aerodynamic position, for example, during a triathlon or a time trial, Triathlon handlebar extension kits are used.

Triathlon handlebar extension kits may be fitted only to bicycles without motor assistance.

Triathlon shift levers are often located at the ends of the handlebar. The brake levers are located at the end of the stock handlebar. When the bike is being ridden with an aerodynamic posture, the brake levers are outside the direct reach of the rider's grip.

- Familiarise yourself with the ride characteristics of a Triathlon handlebar extension kit and how to reach for the brake levers before riding the bike on the road.
- Make sure that you rule out other risk factors, such as the untrained use of clipless pedals, when you are practising using the handlebar.
- Adapt your riding style to the changed ride characteristics.

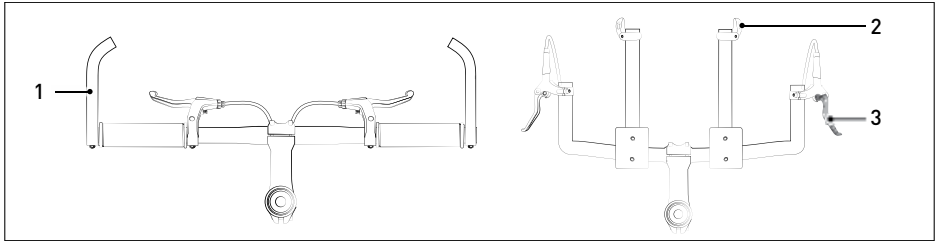

Fig. Bar ends and Triathlon handlebar extension kit (example)

1 Bar ends

2 Shift lever

3 Brake lever

## 6.3.2 Additional regulations

In order to travel on the road, bicycles must be fitted with two independent brakes and a bell.

## 6.3.3 Riding with children

Find out whether children are allowed to ride with you on your bicycle (see section “Bike passport” on page 99). Observe the following information when riding with children:



### WARNING

Additional weight changes the riding characteristics of the bicycle.

#### Risk of accident and injury!

- ▶ Observe the maximum trailer load and the maximum permitted total weight.
- ▶ After installing a child seat or child trailer, familiarise yourself with how the bicycle handles differently in a safe place away from the road.



### WARNING

Fitting a child seat or trailer coupling incorrectly can cause components to break.

#### Risk of accident and injury!

- ▶ Have a bicycle dealer install your child seat, trailer and trailer coupling.

- Your bicycle dealer will be happy to help you select suitable child seats, child trailers and trailer systems for your bike.
- Read the user manual belonging to the child seat, child trailer or trailer system.
- Observe the permitted maximum weight for the child seat, the child trailer or the trailer system specified in the accompanying user manual.

- Only children younger than 8 years old who weigh less than 22 kg may be transported in a child seat or child trailer.
- You must be a minimum of 16 years of age to transport a child in a child seat or child trailer.
- Only transport a child in a child seat or child trailer if they are wearing an adapted bicycle helmet that is certified according to standard DIN EN 1078 and bears the CE mark.
- When using child seats, child trailers and trailer systems, always observe the regulations applicable in your country and region.
- Make sure that there are no dangling straps which might get caught in one of the wheels.
- Brake earlier and anticipate slower braking and more sluggish steering behaviour.
- Practice mounting and dismounting the bicycle in a safe place away from the road.
- Teach your child to behave appropriately during the journey.
- Ride defensively and anticipate the traffic situation well in advance.

### 6.3.3.1 Riding with a child in the child seat

- Always mount the child seat on the frame. Securing attachments (child seats) to the luggage carrier using clamps can result in breakages and is strictly prohibited.
- When having a child seat fitted, make sure the saddle springs and the sprung seat-post are completely enclosed.
- When having a child seat fitted, make sure that all moving components are enclosed.

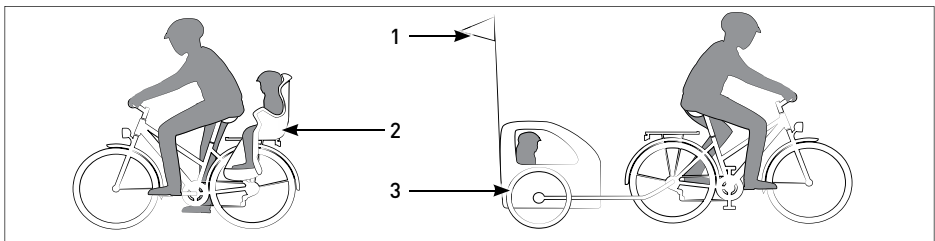

Fig. Riding with children

1 Flag

2 Child seat

3 Child trailer

## 6.3.3.2 Riding with a child in the child trailer



### **WARNING**

A bicycle with a child trailer attached is much longer and is more difficult to stop due to the propulsive force of the child trailer.

#### **Risk of accident and injury!**

- ▶ Always ride bicycles with a child trailer attached at moderate speeds.
  - ▶ Remember that the stopping distance will be much longer.
- 

Observe the following points when using child trailers:

- Only have a child trailer fitted if your bicycle is suitable (see section “Bike passport” on page 99).
- Only child trailers certified according to DIN EN 15918 can guarantee maximum safety.
- Observe the maximum trailer load:
  - The maximum trailer load for trailers with no brakes is 40 kg.
  - The maximum trailer load for trailers with brakes is 80 kg.
- In a safe place away from the road, familiarise yourself with how the bicycle handles differently as a result of the increase in weight and additional length.
- Do not carry more than two children in the child trailer.
- Always use a child trailer fitted with a fully functional lighting system that meets all the relevant national and regional regulations.
- To ensure your child remains safely seated, select a child trailer fitted with a restraint system.
- Have the child trailer fitted with a flexible flagpole at least 1.5 m in length topped with a luminous flag and make sure covers are fitted over the spokes and wheel houses.
- In order to guarantee maximum safety, select a child trailer with a robust passenger compartment and integral safety belts.

## 6.4 Replacing bicycle components



### **WARNING**

Replacing bicycle components with incorrectly selected replacement parts may prevent the bicycle from functioning correctly.

#### **Risk of accident and injury!**

- ▶ Always use original replacement parts.
-

## 6.5 Residual risks

Even if you observe all the safety and warning instructions, you may still be exposed to the following unforeseeable residual risks while using the bicycle:

- Errors by other road users
  - Unforeseeable road conditions, such as black ice caused by freezing rain
  - Unforeseeable material defects or material fatigue can cause the breakage or functional failure of bicycle components
- Ride defensively and anticipate the traffic situation well in advance.
- Check the bicycle for cracks, scratches, discolouration or component damage prior to each journey.
- Before each journey, check that the safety-relevant components (e.g. brakes) work.
- After a fall or accident, have a bicycle dealer inspect the bicycle for damage.

### 7 Basic adjustments

The following section contains information on how to

- inspect your bicycle before starting your journey,
- adjust the seat position and
- make other basic adjustments.



If you do not have the necessary know-how and tools to make basic adjustments, have your bicycle dealer perform these adjustments.

#### 7.1 Before your first trip

Your bicycle dealer has completely assembled and adjusted the bike. The bike is thus roadworthy.

Familiarise yourself with the most important functions on the bicycle before setting off on your first trip.

- You should also familiarise yourself with the riding characteristics of your bicycle in a safe place away from the road.
- If you are unfamiliar with the brake lever assignment to the front and rear wheel brakes, have a bicycle dealer change the brake lever configuration.
- Familiarise yourself with how your bike brakes at a low speed in a safe place away from the road.
- If your bicycle is fitted with hydraulic brakes, press both brake levers several times to centre the brake linings in the calliper.
- Practice changing gear in a safe place away from the road so that you do not have to take your eye off the road when changing gear.
- Check whether your seating position is sufficiently comfortable, especially for longer journeys, and whether you can easily operate all the components on the handlebar while riding.

#### 7.2 Checks before each journey

- Before each journey, check the bicycle for damage and excessive wear.
- If you discover any damage or excessive wear, do not use the bicycle.
- Have the damaged or worn components replaced by a bicycle dealer.



Before each journey, check the following:

- **Brakes**
  - Push the bicycle and operate each of the brakes, the respective wheels must lock up.
- **Gearshift system**
  - Lift the bicycle by the frame so that the rear wheel is free to move and turn the pedals slightly.
  - Check whether the gears change easily and without making unusual noises.
- **Frame, fork and seatpost**
  - Visual inspection: The frame, fork and seatpost must not be cracked, deformed or discoloured.
- **Quick-release devices**
  - Check whether all quick-release devices are closed firmly and secured correctly.
  - Check the pretension of all quick-release devices.
- **Screw and plug connections**
  - Visual inspection: The screw and plug connections must be closed correctly.
- **Pedal mechanism**
  - Check whether the pedal mechanism functions properly and is secured correctly.
- **Lights**
  - Check whether the headlamp and tail lamp function correctly.
- **Bell**
  - Check whether the bell makes a clear sound.
- **Handlebar and handlebar stem**
  - Check that the handlebar and handlebar stem are securely seated.
  - Visual inspection: The handlebar and handlebar stem must not be cracked, deformed or discoloured.
- **Tyres**
  - Check the tyre inflation pressure.
  - Check the tyres for cracks and foreign objects.
- **Rims and spokes**
  - Visual inspection: The rims must not be cracked, deformed or worn excessively.
  - Check that the spokes for even tension.

### 7.3 Adjusting the seat position

Finding the best seating position depends on

- the height of the rider,
- the size of the bicycle frame
- and the handlebar and saddle settings.



#### **WARNING**

Incorrectly adjusting the height of the saddle or handlebar may affect the function and safety of the bicycle components.

#### **Risk of accident and injury!**

- ▶ Observe the minimum insertion depth of the seatpost.
- 



#### **CAUTION**

An incorrect seating position can cause muscle tension and joint pain.

#### **Risk of injury!**

- ▶ Have the seat position adjusted by a bicycle dealer.
- 



#### **CAUTION**

An incorrect seating position can make it difficult to reach the operating elements on the handlebar.

#### **Risk of accident and injury!**

- ▶ Adjust the handlebar and saddle in such a way that your seating position is comfortable and you can easily reach all the components on the handlebar while riding.
- 

Read the section "Seating position" on page 18 for information on the key characteristics of an appropriate seating position.

The correct seating position may also depend on how the bicycle will be used, e.g. predominantly for sport.

Read the section "Adjusting the saddle" on page 80 for information on adjusting the saddle height.

Do not adjust the handlebar height unless you have the necessary know-how and tools (see section "Handlebar" on page 77).

If your bicycle is fitted with an Ahead handlebar stem, have the handlebar height adjusted by a bicycle dealer.

If you cannot achieve a comfortable seating position by adjusting the saddle and handlebar, you can improve your seating position by replacing specific components. Components that can be replaced include

- seatpost,
- saddle,
- handlebar stem,
- handlebar,
- cranks.

→ If you cannot achieve a comfortable seating position, have a bicycle dealer fit components with different dimensions.

→ Please note that with racing bikes there may be less foot space because different cranks or tyres are fitted.



If you decide to sell or give the bicycle to another person, this person has the option of replacing components to achieve an appropriate seating position.

#### 7.4 Observe the rotation direction of screws

→ Tighten nuts, screws and quick-release axles by turning them clockwise.

→ Unscrew nuts, screws and quick-release axles by turning them anti-clockwise.



If there are deviations from these rules, you can find the relevant direction of rotation in the relevant section.

#### 7.5 Observing the torque values

The torque value refers to the rotational force applied to screw connections on the bicycle, for example. In order to tighten the screw connections correctly, always observe the torque values.



### WARNING

Incorrectly tightened screw connections can result in material fatigue and eventually cause the screw connections to break.

#### **Risk of accident and injury!**

- ▶ If the screw connections are loose, do not use the bicycle.
- ▶ Tighten the screw connections with the correct torque values.

## 8 Brakes



### **WARNING**

In wet conditions, the effectiveness of the brakes may decrease and the braking distance may increase.

#### **Risk of accident and injury!**

- ▶ Adapt your riding style and speed to the weather and road conditions.
- 



### **WARNING**

Actuating only the front wheel brake may cause you to somersault over the handlebar.

#### **Risk of accident and injury!**

- ▶ Always use the brake lever for the front wheel with care when travelling at high speeds.
  - ▶ Adjust the braking force of the brakes to the riding situation.
  - ▶ Always apply both brakes simultaneously when braking.
- 



### **WARNING**

If the rear wheel locks up, it may cause you to have an accident.

#### **Risk of accident and injury!**

- ▶ Use the rear wheel brake carefully when cornering.
- 



### **WARNING**

Incorrect brake linings may decrease or excessively enhance the braking performance or even cause the brake to fail.

#### **Risk of accident and injury!**

- ▶ Always replace brake components with original replacement parts.
- 



### **WARNING**

Adjusting the power modulator incorrectly can result in serious accidents.

#### **Risk of accident and injury!**

- ▶ Find a safe place away from the road to familiarise yourself with the function of the brakes and power modulator.
- 

A brake is a technical device used to decelerate an object. "Braking system" is a generic term used to describe the individual components in their entirety.

A bicycle is fitted with a minimum of two brakes that act on the front and rear wheel independently of one another.

The following brake types may be fitted:

- Coaster brake
- Roller brake
- Rim brake
- Disc brake
- Drum brake

→ Check Section “Bike passport” on page 99 to see which brakes the bicycle is fitted with.

→ For shorter braking distances, apply both brakes evenly.

## 8.1 Inspecting the brakes

Carry out the following steps on the front and rear wheel brakes.

1. Check that all the screws on the braking system are securely seated.
2. Check whether the brake lever is secured to the handlebar in such a way that it cannot be turned.
  - If you notice loose screw connections, ask your bicycle dealer to tighten them.
3. Press the brake lever all the way down and check whether the gap remaining between the brake lever and grip is at least 1 cm.
  - If the gap is less than 1 cm, have your bicycle dealer adjust the braking system.
4. Check the wear on the brake linings.
  - If in any doubt, ask your bicycle dealer to show you how to inspect signs of wear.
5. Move the brake discs on the front and rear wheel back and forth slightly to check whether they are seated snugly.
6. Check whether the front or rear wheel locks up when the respective brake lever is pressed.
  - If you notice a reduced braking force, have your bicycle dealer adjust the braking system.

## 8.2 Brake lever assignment

The brake levers are assigned in the basic configuration as follows:

If the bicycle has only one brake lever, it is attached on the right of the handlebar and operates the front brake.

If the bicycle has two brake levers, the right brake lever operates the rear brake and the left brake lever operates the front brake.

→ Familiarise yourself with the brake lever assignment before starting your journey. If you wish to change the brake lever assignment, consult a bicycle dealer.

## 8.3 Rim brake



### WARNING

Wear can cause the rim to break.

#### Risk of accident and injury!

- ▶ Have the rims checked by a bicycle dealer at least once a year or after 1000 km.

When the brake lever on a mechanical rim brake is pressed, the brake cable pulls the brake arms together and the brake linings are pushed against the rim.

When the brake lever on a hydraulic rim brake is pressed, the brake pistons in the braking unit are pushed outwards by oil pressure and the brake blocks are pressed onto the rim.



If you do not have the necessary know-how and tools to adjust the rim brake, have your bicycle dealer perform the adjustments.

### 8.3.1 Rim brake with quick-release fastener



### WARNING

An open quick-release fastener can cause the rim brake to fail.

#### Risk of accident and injury!

- ▶ Make sure that the quick-release fastener is closed.

The quick-release fastener lever on a rim brake allows you to quickly remove and refit the wheels.

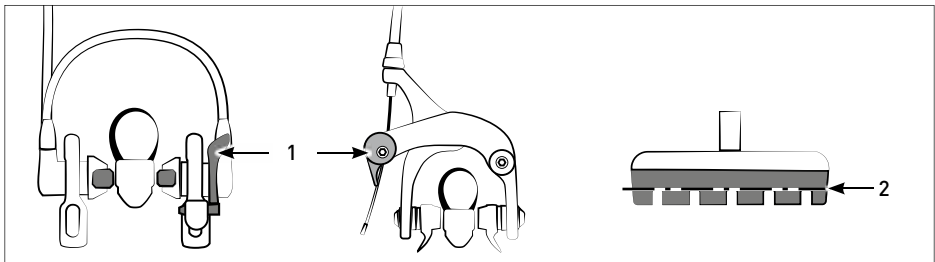

Fig. Rim brake

1 Quick-release fastener lever

2 Wear limit

### 8.3.2 Basics

The brake linings and rim slowly abrade when the rim brake is used. If the rim brake is fitted with a cable, the brake cable will also wear. If the rim brake is hydraulic, the brake fluid will also degrade over time.

In order to ensure that the rim brake remains fully operational at all times, follow the maintenance instructions below.

- Remove any dirt from the rim brake components and rim immediately using a slightly damp cloth.
- Check that all the screws on the braking system are securely seated.
- Check whether the brake lever is secured to the handlebar in such a way that it cannot be turned.
- If you notice loose screw connections, ask your bicycle dealer to tighten them, taking the torque into consideration.
- Repeatedly pull the brake lever and check whether the brake cable is stuck or whether you can hear scratching noises, or whether brake fluid is leaking from the lines, connections or brake linings.
- Check for damage to the brake cable casing or torn filaments (visual check).
  - Do not use the bicycle if the brake cable is faulty or there is leaking fluid.
  - Press the brake lever all the way down and check whether the gap remaining between the brake lever and grip is at least 1 cm.
- If the gap is less than 1 cm, have a bicycle dealer adjust the rim brake.
- Check that the bicycle wheels are locked when the rim brake is applied.
  - If you notice a reduced braking force, have your bicycle dealer adjust the braking system.
- Listen for unusual noises when operating the rim brake.
  - If you hear any unusual noises, have a bicycle dealer check the braking system.

### 8.3.3 Checking the brake linings

- Check whether the brake linings have reached their wear limit.
  - If in doubt, ask a bicycle dealer to check the wear limit of the brake linings.

The brake linings must be replaced before they reach their wear limit.

Have a bicycle dealer replace the brake linings and then adjust the braking system.



Ask a bicycle dealer to explain the wear limit of the rim brake.

- Press the brake lever all the way down and check whether the gap remaining between the brake lever and grip is at least 1 cm.
  - If the gap is less than 1 cm, have the braking system adjusted by a bicycle dealer.
- Check whether the brake blocks wear evenly on both sides of the rim (visual inspection).
  - If the brake linings wear unevenly or at an angle, have the braking system checked by a bicycle dealer.
- Check the brake linings for damage and heavy soiling (visual inspection).
  - Clean the brake linings if they are extremely dirty.
  - Have damaged brake linings replaced by a bicycle dealer.
- Check whether the brake blocks rub centrally on the side of the rim.
  - The brake blocks should be positioned in such a way that they follow the curvature of the rim as closely as possible.
- Check whether it is possible to twist the brake blocks.
  - If you are able to twist the brake blocks, have them adjusted by a bicycle dealer.
- Check whether the brake blocks move evenly and symmetrically towards and away from the rim when the brake lever is pulled and released (visual inspection).
  - If the brake blocks move unevenly, have the braking system checked by a bicycle dealer.

### 8.4 Operating the rim brakes

The rear wheel locks up earlier than the front wheel when the same braking force is applied.

The front and rear wheel on your bicycle are fitted with different types of brake, depending on the model.

- To brake, pull the brake lever towards the handlebar using your fingers.
- Regulate the braking action by increasing or decreasing the force with which you pull the brake lever.
- To stop braking, simply release the brake lever.

For shorter braking distances, apply both rim brakes evenly or use the hand and coaster brake.



## 8.5 Adjusting the rim brakes



### WARNING

An incorrectly adjusted braking system may reduce the braking performance.

#### Risk of accident and injury!

► The braking system must always be adjusted by a bicycle dealer.

### 8.5.1 Adjusting the grip range

The brake lever can be moved closer to the grip by adjusting the grip range.

→ Adjust the brake lever to a position where it is easy to operate it while you are riding and without removing your hand from the handlebar.



The tension of the brake cable changes when the grip range is adjusted.

1. Screw in the adjusting screw until you are able to operate the brake lever safely (see Fig. "Adjusting the brake lever").

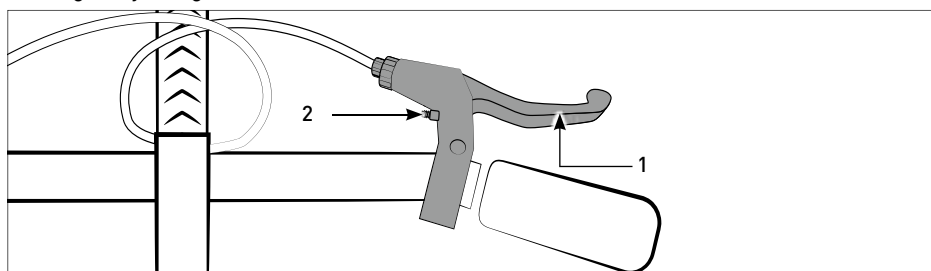

Fig. Adjusting the brake lever

1 Brake lever

2 Adjusting screw



The adjusting screw will be a crosshead or hexagon socket screw, depending on the model.

2. Adjust the tension of the brake cable.

### 8.5.2 Adjusting the brake cable



If the distance between the left and right brake blocks and the rim varies by more than 1 mm, your bicycle dealer must restore the braking system to its initial set-up before the brake cable can be adjusted.

1. Unscrew the lock nut one or two revolutions in an anti-clockwise direction (see Fig. "Adjusting the brake cable").

2. Screw the knurled nut clockwise or anti-clockwise until the distance between the brake blocks and the rim is 1 to 2 mm on both sides (see Fig. "Mechanical rim brake").
  - Pull the brake cable away from the knurled nut slightly so that the knurled nut is easier to turn.
3. Unscrew the knurled nuts a maximum of five revolutions.
  - If you are unable to adjust the brake blocks, have the braking system checked by a bicycle dealer.
4. Pull the brake lever towards the grip and check whether the gap between the brake lever and grip is at least 1 cm.
5. Turn the lock nut in a clockwise direction and tighten with appropriate force.

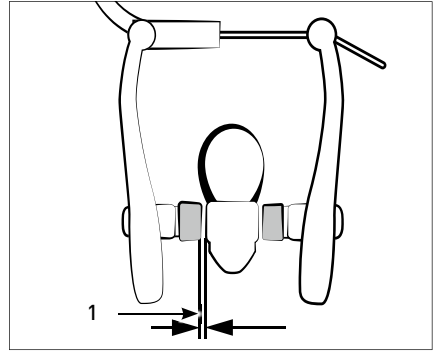

Fig. Mechanical rim brake

1 Gap

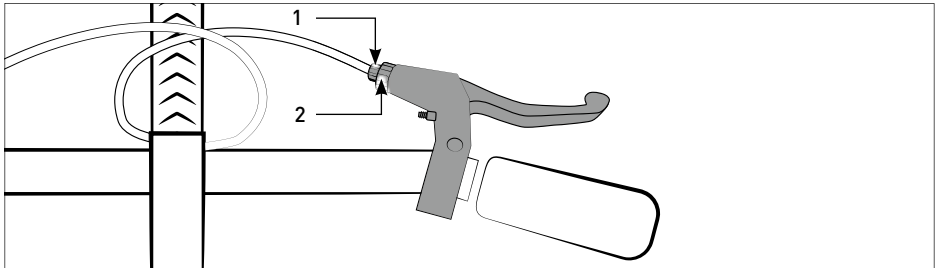

Fig. Adjusting the brake cable

1 Knurled nut

2 Lock nut

## 8.6 Disc brake



### WARNING

Wear can cause the disc brake to fail.

#### Risk of accident and injury!

- ▶ Have the disc brake checked by a bicycle dealer at least once a year or after 1000 km.
- 



### CAUTION

Making contact with hot brake discs can cause burns.

#### Risk of injury!

- ▶ Allow brake discs to cool before touching them.
- 

### NOTE

Brake linings may vitrify if used continuously for prolonged periods.

#### Risk of damage!

- ▶ When travelling down long descents, brake intermittently with greater force, if safe to do so.
- 

### NOTE

The brake may be damaged when the front or rear wheel is removed.

#### Risk of damage!

- ▶ The front or rear wheel should always be removed or fitted by a bicycle dealer.
- 

### NOTE

Braking fully with newly fitted brake linings will cause the linings to vitrify.

#### Risk of damage!

- ▶ Wear in new disc brakes in a safe place away from the road.
- 

### 8.6.1 Basics

When the brake lever is pulled, the brake pistons located in the caliper on the disc brake are forced outwards. The brake pistons press the brake linings against the brake disc.

- Check the disc brake regularly for wear and ensure it functions properly.
- Remove any dirt from the disc brake components and brake disc immediately using a slightly damp cloth.

→ If you have disc brakes, clean the brake discs regularly with brake cleaning fluid or warm water.

The brake linings and brake disc slowly abrade when the disc brake is used.

If the disc brake is fitted with a cable, the brake cable will also wear.

If the disc brake is hydraulic, the brake fluid will also degrade over time.

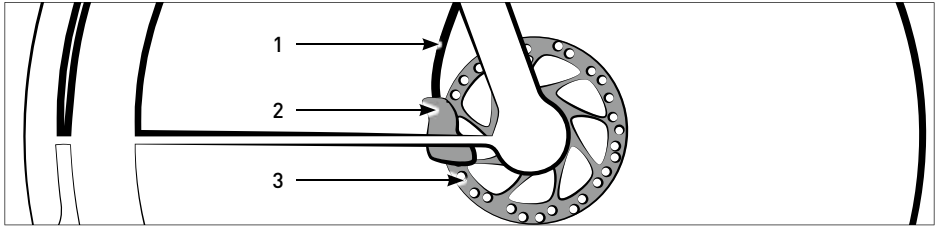

Fig. Hydraulic disc brake

1 Hydraulic line

3 Brake disc

2 Caliper

Ask a bicycle dealer about devices for checking the wear on the brake linings. Depending on your brake type, this may be the transport lock, for example.

→ Carry out the following steps on the front and rear wheel brakes.

1. Check whether the brake linings move evenly and symmetrically towards and away from the brake disc when the brake lever is pulled and released.

→ If you can move the brake disc or the brake pads in an uneven fashion, have the brakes checked by your bicycle dealer.

2. Pull the brake lever and check whether brake fluid escapes from the lines, connections or brake linings.

→ If brake fluid is leaking out, do not use the bicycle.

→ Have a bicycle dealer replace the brake disc.

If the brake linings are new or the brake linings or brake disc have been replaced, the disc brakes have to be worn in.

→ To do so, please observe the manufacturer's instructions or ask a bicycle dealer.

→ If the disc brakes do not work sufficiently after braking, or if you hear unusual noises when braking, have your bicycle dealer inspect the disc brakes.

### 8.6.2 Operating the disc brake

The rear wheel locks up earlier than the front wheel when the same braking force is applied.

The front and rear wheel on your bicycle are fitted with different types of brake, depending on the model.

- To brake, pull the brake lever towards the handlebar using your fingers.
- Regulate the braking action by increasing or decreasing the force with which you pull the brake lever.

To release the disc brake, let the brake lever go.

For shorter braking distances, apply both brakes evenly.

### 8.6.3 Adjusting the disc brake



#### **WARNING**

Incorrectly adjusted brakes can reduce the braking performance or cause the brakes to fail.

#### **Risk of accident and injury!**

- ▶ Always have the brakes adjusted by a bicycle dealer.
- ▶ If required, ask a bicycle dealer to explain the brake adjustment process.



If you do not have the necessary know-how and tools to adjust the disc brake, have your bicycle dealer perform the adjustments.

### 8.6.4 Replacing the brake linings



#### **WARNING**

If the wrong brake linings are installed or the linings are installed incorrectly, they may cause a functional impairment, such as disc brake failure.

#### **Risk of accident and injury!**

- ▶ Always use original brake linings designed specifically for disc brakes.
- ▶ Always seek professional advice when purchasing brake linings.
- ▶ Have a bicycle dealer replace the brake linings.

- Check if the brake linings are worn.
- Have a bicycle dealer replace the brake linings.

## 9 Coaster brake



### WARNING

The coaster brake has no effect if the chain has dropped.

#### Risk of accident and injury!

- ▶ If the coaster brake fails, brake carefully using the brake lever for the front wheel and, if fitted, the brake lever for the rear wheel.

A coaster brake is often part of the equipment of bicycles with hub gears and bicycles without a shifting system. The coaster brake is part of the bicycle's rear hub and is operated using the pedals.

If you can turn the pedal drive backwards without any resistance, your bicycle is not equipped with a coaster brake.

### 9.1 Basics

When the coaster brake is actuated, frictional forces are applied to the rear wheel's hub to slow down the rear wheel. Coaster brakes only start to wear after long periods of use due to the design.

Regularly check that the coaster brake works.

1. Hold the counterholder and make sure it sits securely on the rear frame chain stay.
  - If the screw on the counterholder is loose, turn in a clockwise direction to tighten.
  - Tighten the screw with appropriate force.
2. Listen for unusual noises when applying the coaster brake.
  - If you hear any unusual noises, have a bicycle dealer check the coaster brake.

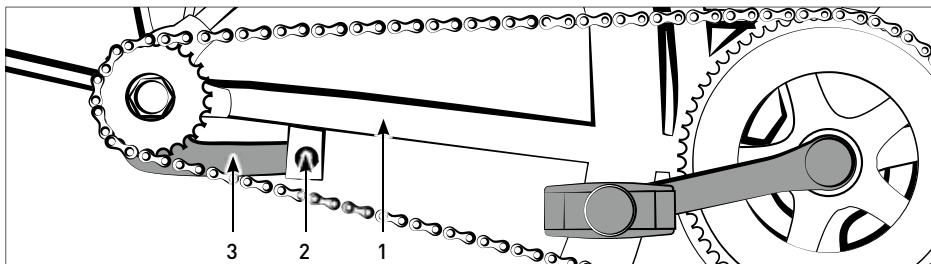

Fig. Brake arm

- 1 Bottom chain-stay tube
- 2 Screw

- 3 Brake arm

## 9.2 Operating the coaster brake

- Push back on the pedal mechanism to brake (see Fig. "Coaster brake").
- Regulate the braking force using the force you apply when pedalling against the resistance.
- Push forward on the pedal mechanism to release the coaster brake.

For shorter braking distances, brake evenly with the hand brake and coaster brake.

## 9.3 Adjusting the coaster brake

 Only your bicycle dealer can carry out adjustments to the coaster brakes.



### **WARNING**

An incorrectly adjusted braking system may reduce the braking performance.

#### **Risk of accident and injury!**

- ▶ Only a bicycle dealer may carry out adjustments to the coaster brake.

If the coaster brake rotates backwards more than 1/6th of a full turn when braking, then have a bicycle dealer adjust the coaster brake.

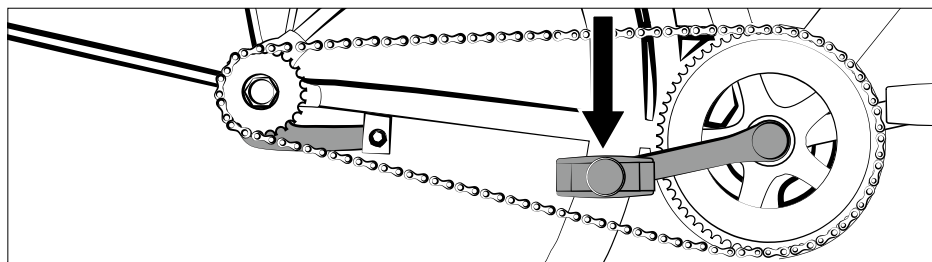

Fig. Coaster brake

## 10 Roller brake

The roller brake is part of the front or rear wheel hub (see Fig. "Roller brake"). When the roller brake is actuated, the brake pad applies pressure to the brake drum through the rotating brake rollers.

### 10.1 Basics

Using the roller brake causes the brake cable, brake rollers, brake pad and brake drum to wear.

### 10.2 Operating the roller brake

The rear wheel locks up earlier than the front wheel when the same braking force is applied.

The front and rear wheel on your bicycle are fitted with different types of brake, depending on the model.

- To brake, pull the brake lever towards the handlebar using your fingers.
- Regulate the braking action by increasing or decreasing the force with which you pull the brake lever.
- Let go of the brake lever to release the roller brake.

For shorter braking distances, apply both brakes evenly.

### 10.3 Adjusting the roller brake

**i** If the roller brake drags when the adjusting screw is completely screwed in, have a bicycle dealer adjust the brake's basic setting first before adjusting the brake cable.

1. Tighten the lock nut by one or two revolutions in an anti-clockwise direction (see Fig. "Adjusting the roller brake").
2. Unscrew the adjusting screw until the roller brake begins to drag without pulling the brake lever.

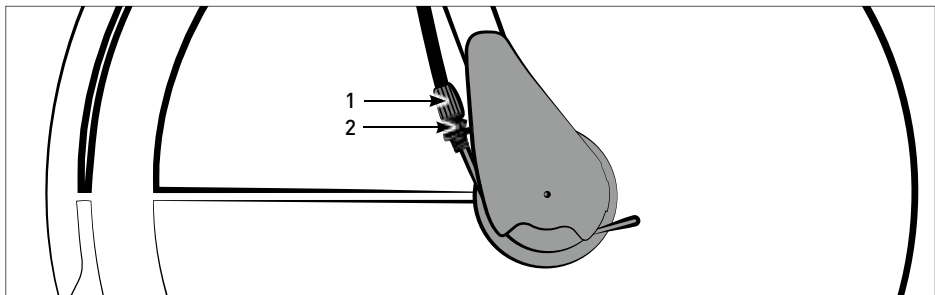

Fig. Roller brake

1 Adjusting screw

2 Lock nut



During this process, grip the brake cable and pull lightly on it to make the adjusting screw turn with greater ease.

- Unscrew the adjusting screws a maximum of five revolutions.
  - Turn the front or rear wheel to check if the roller brake is dragging.
3. Gradually turn the adjusting screw until the front and rear wheels freely rotate when the brake lever is not pulled.
  4. Pull the brake lever towards the grip and check whether the gap between the brake lever and grip is at least 1 cm.
    - If you are unable to adjust the roller brake, have a bicycle dealer check the roller brake.
  5. Turn the lock nut in a clockwise direction and tighten with appropriate force.

## 11 Drum brake

The drum brake is part of the front or rear wheel hub (see Fig. "Drum brake").

 If you do not have the necessary know-how and tools to adjust the drum brake, have your bicycle dealer perform adjustments to the drum brake.

### 11.1 Basics

When the brake lever on a drum brake is pressed, the two brake pads in the wheel's hub then press against the hub shell.

Using the drum brake causes the brake pads, the hub casing and the brake cable to wear.

 The front wheel hub may also feature a dynamo (see Section "Lighting" on page 68).

### 11.2 Operating the drum brake

The rear wheel locks up earlier than the front wheel when the same braking force is applied.

The front and rear wheel on your bicycle are fitted with different types of brake, depending on the model.

- To brake, pull the brake lever towards the handlebar using your fingers.
- Regulate the braking action by increasing or decreasing the force with which you pull the brake lever.
- Let go of the brake lever to release the brake.

For shorter braking distances, apply both brakes evenly.

### 11.3 Adjusting the drum brake

 If the drum brake drags when the adjusting screw is completely screwed in, have a bicycle dealer adjust the drum brake's basic setting first before adjusting the brake cable.

1. Tighten the lock nut by one or two revolutions in an anti-clockwise direction (see Fig. "Adjusting the drum brake").
2. Unscrew the adjusting screw until the brake begins to drag without pulling the brake lever.

During this process, grip the brake cable and pull lightly on it to make the adjusting screw turn with greater ease.

- Unscrew the adjusting screws a maximum of five revolutions.
  - Turn the front or rear wheel to check if the drum brake is dragging.
3. Gradually turn the adjusting screw until the front and rear wheels freely rotate when the brake lever is not pulled.
  4. Pull the brake lever towards the grip and check whether the gap between the brake lever and grip is at least 1 cm.
    - If you are not able to adjust the drum brake in this way, ask your bicycle dealer to inspect the drum brakes.
  5. Turn the lock nut in a clockwise direction and tighten with appropriate force.

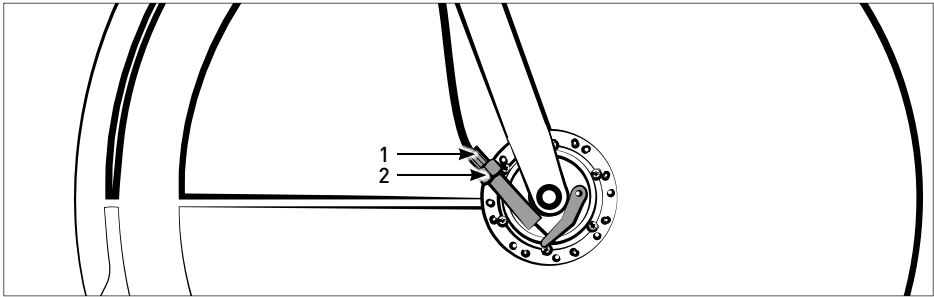

Fig. Drum brake

1 Adjusting screw

2 Lock nut

## 12 Drives

Bicycles are driven manually. The pedal drive transmits the muscle power exerted while pedalling to the chain (chain drive) or belt (belt drive), which in turn moves the rear wheel, thus driving, i.e. propelling the bicycle.

→ Refer to the following sections “Chain Drive” or “Belt Drive” for information on the type of drive your particular model of bicycle has and follow the safety and maintenance information.

### 12.1 Pedal drive

#### 12.1.1 Basics

Components of the pedal drive:

- Pedal
- Crank
- Bottom bracket
- Chain wheel.

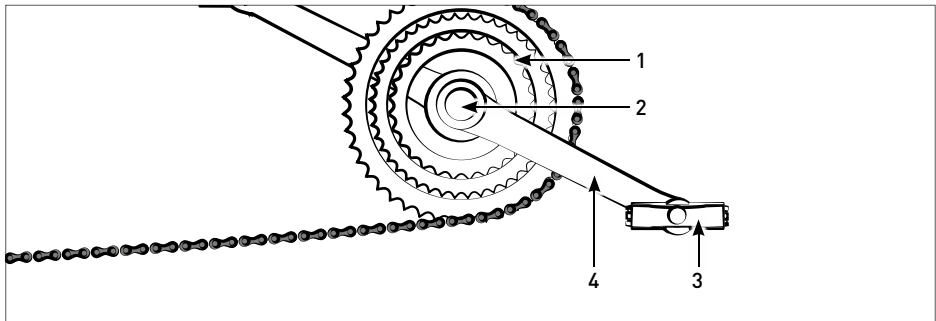

Fig. Pedal drive

- 1 Chain wheel
- 2 Bottom bracket

- 3 Pedal
- 4 Crank

#### 12.1.2 Operating the pedal drive

→ Set the pedal drive into motion by turning the pedals (pedalling) so that the chain or belt rotates to move the bicycle.

#### 12.1.3 Checking the pedal drive

- Make sure that the crank arm, bottom bracket and pedals are fixed by trying to move the pedals from side to side and vertically up and down by applying a little pressure.
- If the crank arm, bottom bracket or pedals move from side to side or up and down, have it checked and if necessary repaired by a bicycle dealer.

## 12.2 Chain drive

### 12.2.1 Basics

Depending on the model, a bicycle with a chain drive can be equipped with the following components/functions:

- Hub shifting system
  - Deraillieur gear
  - Coaster brake
- Clean the chain using a clean cloth with a dab of oil applied, if required.
- If necessary, clean the cogs and chain rings with a soft brush.
- Regularly oil the chain with general-purpose oil:
- After cleaning
  - After riding in the rain
  - After 15 hours of riding
- Make sure that none of the chain drive components are damaged.

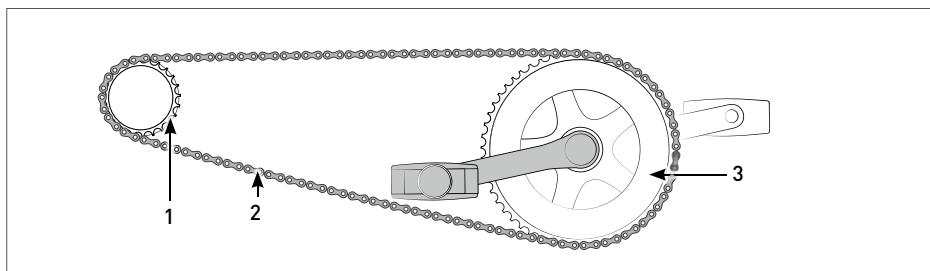

Fig. Chain drive

1 Cog

3 Chain wheel

2 Chain

- If the dirt on the chain is stubborn and cannot be removed using the methods described above or the chain drive components are damaged, please consult a bicycle dealer.

### 12.2.2 Operating the chain drive

- Turn the pedals:  
The pedal drive transmits the muscle power exerted while pedalling to the chain, thus setting the chain drive into motion.  
The rotation of the chain acts on the rear wheel, thus propelling the bicycle.

### 12.2.3 Adjusting the chain drive

- Have a bicycle dealer replace the cog or chain wheel if you find individual teeth are dangerously pointed (so-called shark teeth).

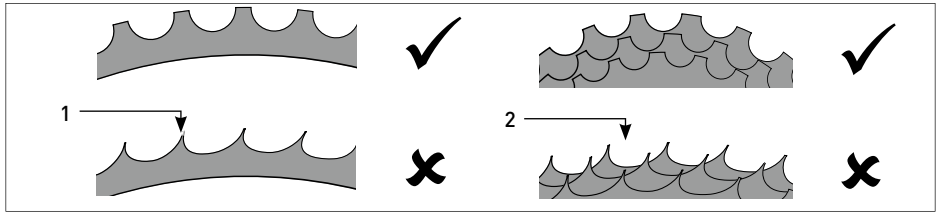

Fig. Wear

1 Chain wheel wear

2 Cog wear

## 12.3 Belt drive

### 12.3.1 Basics

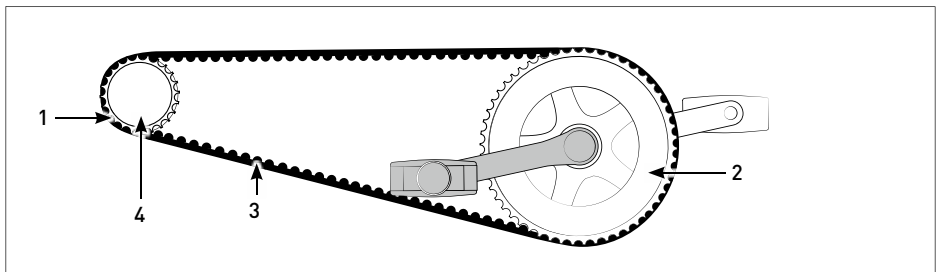

Fig. Belt drive

1 Rear pulley

3 Belt

2 Front pulley

4 Rear side flange

Depending on the model, a bicycle with a belt drive can be equipped with the following components/functions:

- Hub shifting system
- Coaster brake

### NOTE

Incorrect handling can damage the belt.

#### Risk of damage!

- ▶ Do not kink, bend, twist, tie up or turn the belt inside out or use it as a spanner.
- ▶ When fitting, do not wind the belt onto the front pulley.
- ▶ Do not use a lever (e.g. screwdriver) to fit the belt.

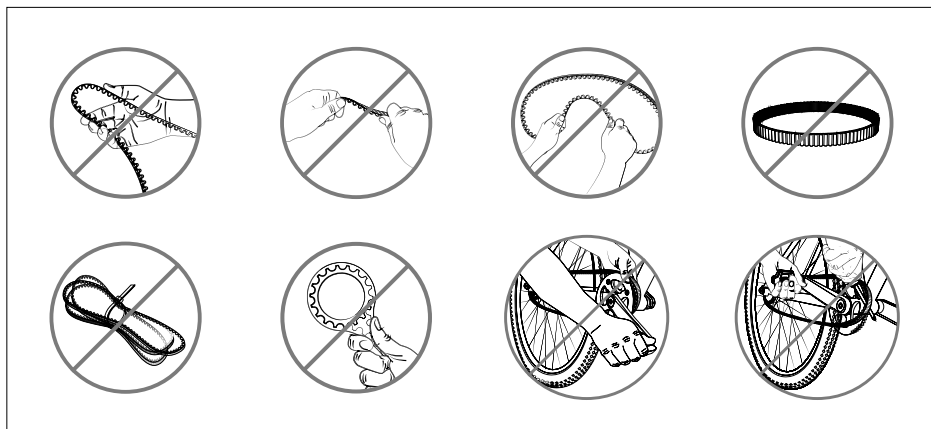

Fig. Types of damage

### 12.3.2 Operating the belt drive

→ Turn the pedals:

The pedal drive transmits the muscle power exerted while pedalling to the belt, thus setting the belt drive into motion. The rotation of the belt acts on the rear wheel, thus propelling the bicycle.

### 12.3.3 Adjusting the belt drive

#### 12.3.3.1 Checking the belt tension

To ensure trouble-free operation of the belt drive, the belt should be tensioned to between 14 kg and 20 kg.

→ Regularly visit a bicycle dealer to have the belt tension checked and adjusted if necessary.

#### 12.3.3.2 Checking belt drive wear

→ Check all belt drive components for wear at regular intervals.

→ Visit a bicycle dealer to have the belt replaced if you find any signs of wear such as pointed teeth, cracks or missing teeth on the belt.

→ Have a bicycle dealer replace the cog if you find individual teeth are dangerously pointed (so-called shark teeth).

→

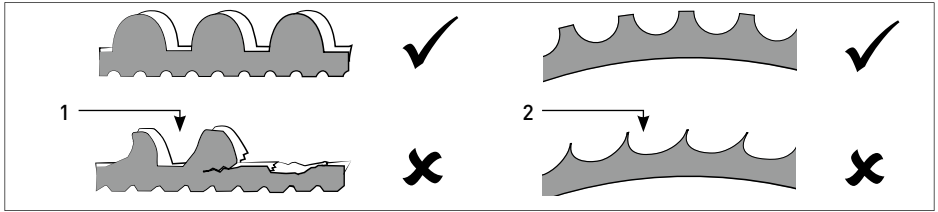

Fig. Wear

1 Belt wear

2 Belt pulley wear



## 13 Gear shifting system

The rider can use the gearshift system to adapt the drive to generate the power required for the route conditions and speed.

Components of the gearshift system include the shiftable gears and the corresponding controls.

A differentiation is made between the following types of gear shifting system:

- Derailleur gear
  - Hub shifting system
- Familiarise yourself with the gearshift system on your bicycle by reading and understanding the corresponding sections in the instruction manual.
- If you have an E-bike, read the separate user manual for E-bikes.

Regular maintenance and servicing keep wear in the gearshift system to a minimum. Shift cables stretch during use.

Observe the following information to avoid premature wear:

- Do not turn the pedals with too much force while shifting gear.
- Do not pedal backwards while shifting gear.
- Shift into the required gear in good time before uphill inclines.
- Regularly check all the components of the gear shifting system as described in the corresponding section for your specific gear shifting system.
- See your bicycle dealer if components show signs of damage, you hear unusual noises while shifting gear or you cannot shift all gears properly.

### 13.1 Operating elements

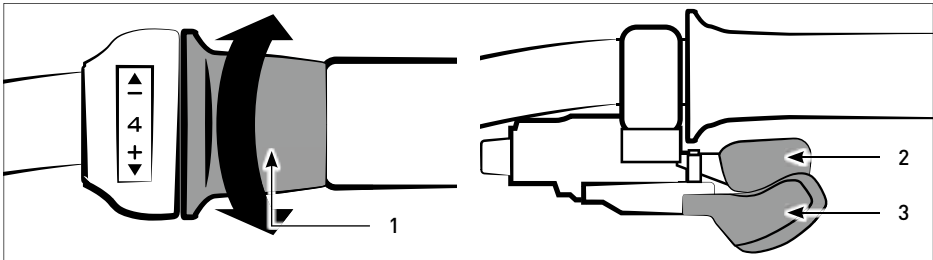

Fig. Operating elements of the gearshift system (example)

- 1 Twist-grip shifter  
2 Rear shift lever

- 3 Front shift lever

## 13.2 Derailleur gear

### 13.2.1 Basics

Bikes with a derailleur gear have 1 to 3 chain wheels on the crank and 7 to 11 cogs on the rear wheel that are selected separately by means of model-specific shifters on the handlebar. The theoretical total number of gears can be determined based on the possible combinations (number of chain wheels × number of cogs).

Choose the chain wheels corresponding to the nature of the route (uphill/flat/downhill). You select the individual gears with the aid of the cogs.

Select:

- A smaller chainwheel on uphill stretches (higher cadence: Less effort required)
- A larger chain wheel on flat/downhill stretches (lower cadence: More effort required)

The smaller the cog you combine with the selected chain wheel, the higher the selected gear and the lower the cadence.

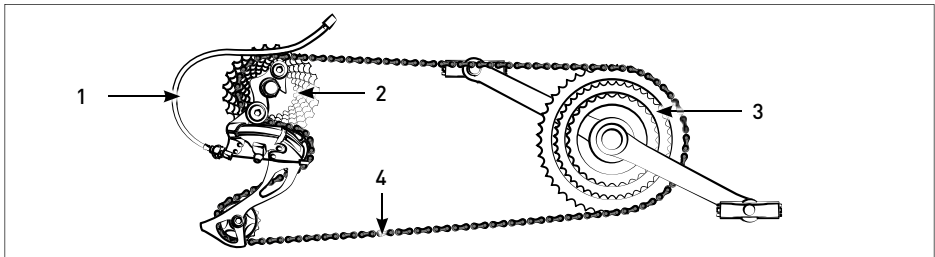

Fig. Derailleur gear

1 Shift cable

2 Cassette on rear wheel

3 Chain wheels on crankset

4 Chain

#### 13.2.1.1 Maintaining the derailleur gear

- Clean the shifters with a damp cloth.
- Remove coarse soiling on accessible components of the gear shifting system with a damp cloth or a soft brush.
- Lubricate the parts of the gear shifting system after cleaning with a suitable lubricant, e.g. multi-purpose oil.
- Immediately remove excess lubricant to avoid soiling and negative environmental impact.

#### 13.2.1.2 Checking the derailleur gear and chain tension

- Check all components of the derailleur gear for damage.
- Check that the rear derailleur gear is vertical or whether it is bent to the side.
- Check that there is sufficient clearance between the rear derailleur gear/chain and spokes.
- Visit your bicycle dealer if components show signs of damage, the rear derailleur gear is bent to the side or there is no or insufficient clearance between the rear derailleur gear/chain and spokes.

The chain tension is maintained with the aid of the jockey wheels in the derailleur gear cage corresponding to the selected chain wheels and cogs.

- Make sure that the chain is tensioned correctly and does not sag.
- Carefully push the derailleur gear cage forward in the direction of the crank and check that the derailleur gear cage returns to its initial position of its own accord.
- Visit your bicycle dealer if the chain is sagging or the derailleur gear cage does not move back of its own accord or snags.

### 13.2.1.3 Gear combinations

#### NOTE

The gear shifting system can be damaged if you combine the gears incorrectly.

#### Risk of damage!

- ▶ Do not use the small chain wheel with the smallest cogs and the large chain wheel with the largest cogs.

Some of the theoretical possible combinations of chain wheels and cogs are not suitable for actual use, as they could reduce riding comfort and increase wear. If, for example, the smallest chain wheel is combined with the smallest cog, due to the extreme skew of the chain, the chain wheels, cogs and chain will wear faster than when more balanced combinations are used.

- Select combinations that ensure the chain runs as parallel as possible (see Fig. "Suitable combinations").
- If you have any problems or are unsure how to use the derailleur gear, ask your bicycle dealer for a demonstration in the handling and use of the derailleur gear.

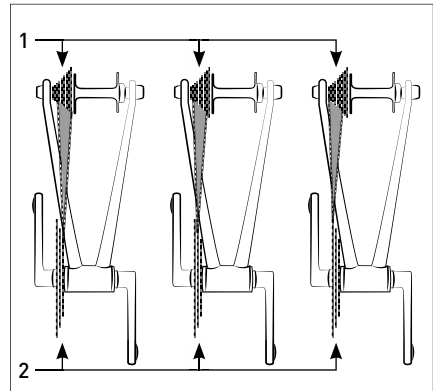

Fig. Recommended combinations

- 1 Cassette on rear wheel
- 2 Chain wheels on crankset

### 13.2.2 Operating the derailleur gear



#### **WARNING**

Being unsure of how to use the gearshift system or experiencing problems with it may distract you from the traffic situation.

#### **Risk of accident and injury!**

- ▶ Familiarise yourself with the gearshift system before riding in traffic on the road.
  - ▶ Stop if you experience problems in operating the gearshift system, e.g. malfunctions.
- 

#### **NOTE**

If used incorrectly, you can damage the gearshift system.

#### **Risk of damage!**

- ▶ Do not turn the pedals with too much force while shifting gear.
  - ▶ Do not pedal backwards while shifting gear.
  - ▶ Shift into the required gear in good time before uphill inclines.
- 

#### 13.2.2.1 Shifter with shift levers

On bikes with shift levers, the shifter for the cassette (cogset) is on the right-hand side of the handlebar and the shifter for the chain wheels on the left-hand side of the handlebar.

- Release the lever after shifting for it to return to its initial position to complete the gear change.
- On the right-hand side of the handlebar (see Fig. "Operating elements of the gear shifting system"), push or pull:
  - the front shift lever by 1 click to shift down by one gear.
  - the front shift lever fully by 2 clicks to shift down by two gears.
- Push the rear shift lever on the right-hand side of the handlebar to shift up by one gear.
- Push the front shift lever on the left-hand side of the handlebar to shift onto a larger chain wheel (lower cadence; more effort required).
- Push or pull the rear shift lever on the left-hand side of the handlebar to shift onto a smaller chain wheel (higher cadence; less effort required).

### 13.2.2.2 Shifter on racing bike handlebar

On bikes with racing bike handlebars, the shifter for the cassette (cogset) is on the right-hand side of the handlebar and the shifter for the chain wheels on the left-hand side of the handlebar.

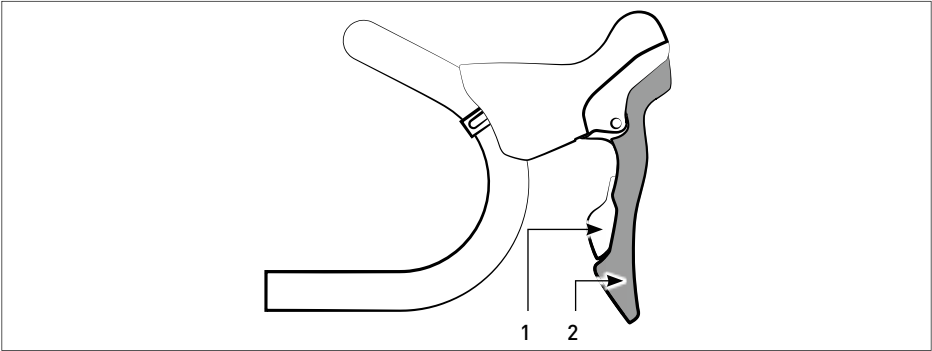

Fig. Shifter on racing bike handlebar

1 Small shift lever

2 Large shift lever

- Release the lever after shifting for it to return to its initial position to complete the gear change.
- On the right-hand side of the handlebar (see Fig. “Shift lever on racing bike handlebar”), push:
  - The large shift lever by 1 click to shift down by one gear.
  - the large shift lever fully by 2 clicks to shift down by two gears.
- Push the small shift lever on the right-hand side of the handlebar to shift up by one gear.
- Push the large shift lever on the left-hand side of the handlebar to shift onto a larger chain wheel (lower cadence; more effort required).
- Push the small shift lever on the left-hand side of the handlebar to shift onto a smaller chain wheel (higher cadence; less effort required).

### 13.2.2.3 Changing gear with twist-grip shifter

- Turn the twist-grip shifter in such a way that the required gear is selected and shown on the display (see Fig. “Operating elements of the gearshift system”).

### 13.2.3 Adjusting the derailleur gear

The gearshift system can be damaged if adjusted incorrectly.

#### **Risk of damage!**

- ▶ Visit your bicycle dealer if you think that your gearshift system needs adjusting.

Adjust the derailleur gear yourself only if you have the required knowledge. Otherwise, have your bicycle dealer adjust it for you.

Adjust the rear or front derailleur gear with the aid of the corresponding cable tensioning screw if unusual noises occur during or after changing gear, or if the gears cannot be changed smoothly or "jump out".

Proceed as follows:

1. Turn the corresponding cable tensioning screw by half a turn clockwise or anticlockwise (see Fig. "Cable tensioning screw").
  - The cable tensioning screw on the shifter adjusts the front derailleur gear.
  - The cable tensioning screw on the rear derailleur gear adjusts the rear derailleur gear.
2. Check whether the noise when changing gear has decreased or increased.
3. Turn the corresponding cable tensioning screw in small steps
  - further in the same direction if the noise has decreased.
  - in the opposite direction if the noise has increased.
4. Carry out steps 1 to 3 until the rear or front derailleur gear are set correctly. Ask your bicycle dealer if the noise persists unchanged or if you are unsure.

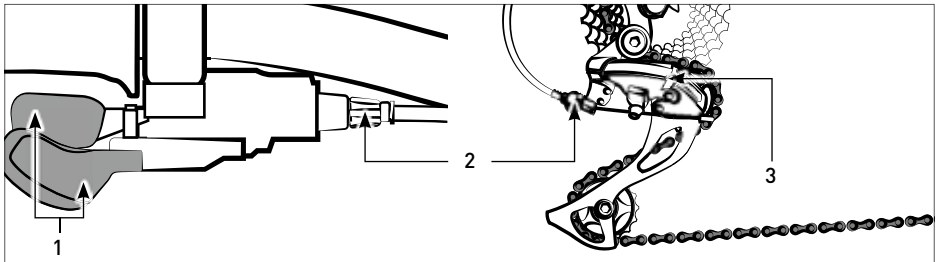

Fig. Cable tensioning screw

1 Shift lever

2 Cable tensioning screw

3 Rear derailleur gear

## 13.3 Hub shifting system

### 13.3.1 Basics

The hub shifting system is located in the rear wheel hub. Depending on the model, the hub shifting system can be operated using either a twist-grip shifter or a shift lever on the right-hand handlebar. The two-speed automatic hub shifting system automatically shifts between first and second gear depending on the speed and therefore has not control unit.

There are also models available with or without a coaster brake.



Intensive use of your bicycle, heavy soiling and exposure to a saline environment can place greater stress on the components of the hub shifting system, which must be inspected and maintained more frequently as a result.

- Have a bicycle dealer change the oil in the hub shifting system once a year.
- Inspect all the components on the hub shifting system for damage.
- Examine the shift cable and check the sheaths covering the shift cable and cable strands for damage and cracks.
- Check the function of the hub shifting system as follows:
  1. Lift the bicycle by the frame until the rear wheel can rotate freely.
  2. Turn the rear wheel using the pedals.
  3. Change through all the gears.
  4. Check that you can shift smoothly to each gear.  
Listen for unusual noises while shifting gear.
- See your bicycle dealer if components show signs of damage, you hear unusual noises while shifting gear or you cannot shift all gears properly.
- In order to minimise wear caused by adverse weather conditions and environmental influences, maintain the components of the hub shifting system using suitable care products. Consult a bicycle dealer for information on suitable care products.

## 13.3.2 Operating the hub shifting system



### **WARNING**

Being unsure of how to use the hub shifting system or experiencing problems with it may distract you from the traffic situation.

#### **Risk of accident and injury!**

- ▶ Familiarise yourself with the hub shifting system before riding in traffic on the road.
  - ▶ Only use the hub shifting system if it does not distract you from the traffic.
  - ▶ Stop if you experience problems in operating the hub shifting system, e.g. malfunctions.
- 

### **NOTE**

If used incorrectly, you can damage the hub shifting system.

#### **Risk of damage!**

- ▶ Do not turn the pedals with too much force while shifting gear.
  - ▶ Do not pedal backwards while shifting gear.
  - ▶ Shift into the required gear in good time before uphill inclines.
- 

### 13.3.2.1 Changing gear using the shift lever

- Release the lever after shifting for it to return to its initial position to complete the gear change.
- Push the front shift lever to shift down a gear.
- Push or pull the rear shift lever to shift up a gear.

### 13.3.2.2 Changing gear with twist-grip shifter

- Turn the twist-grip shifter in such a way that the required gear is selected and shown on the display (see Fig. "Operating elements of the gearshift system").

## 13.3.3 Adjusting the hub shifting system

### **NOTE**

The gearshift system can be damaged if adjusted incorrectly.

#### **Risk of damage!**

- ▶ Visit your bicycle dealer if you think that your gearshift system needs adjusting.
-



Only adjust the hub shifting system yourself if you have the necessary know-how and have already done so. Otherwise, have your bicycle dealer adjust it for you.

If the hub shifting system no longer functions correctly, adjust the shift cable tension. Proceed as described in the relevant section about the hub shifting system.

### 13.3.3.1 3-gear hub shifting system

1. Change to second gear.
2. Loosen the lock nut on the housing for the hub shifting system by turning it in an anti-clockwise direction (see Fig. "Nexus" setting").
3. Align the marking in the viewing window exactly central in relation to the two lines/arrows by screwing the knurled nut clockwise or anti-clockwise.
4. Carefully turn the lock nut in a clockwise direction and tighten it by hand.

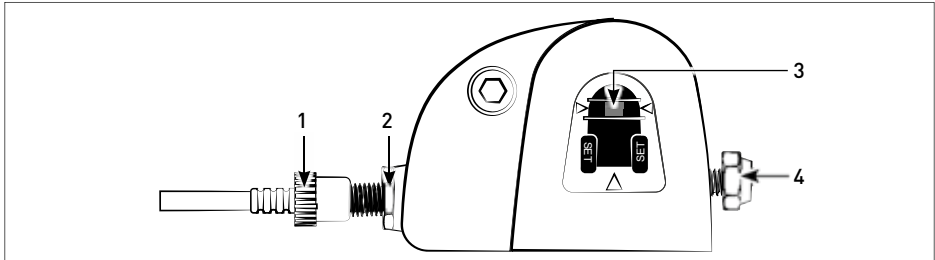

Fig. "Nexus" adjustment

- |               |                |
|---------------|----------------|
| 1 Knurled nut | 3 Marking      |
| 2 Lock nut    | 4 Fixing screw |

To remove the rear wheel, loosen the fixing screw and remove the click box from the axle (see Fig. "Nexus setting").

### 13.3.3.2 5-gear hub shifting system, 7 or 8-gear hub shifting system and 11-gear hub shifting system

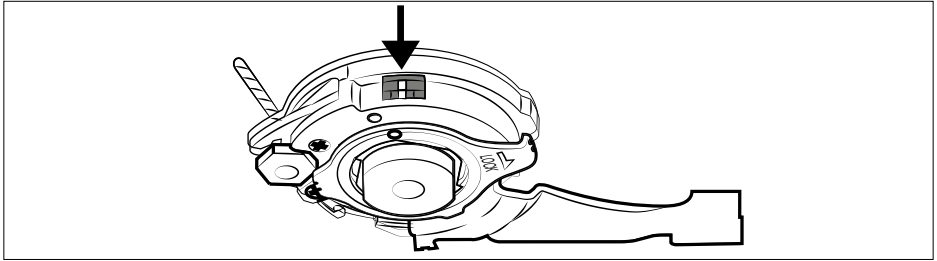

Fig. Marking on the rear wheel hub

1. Change to:
  - 2. gear (5-gear hub shifting system)
  - 4. gear (7 or 8-gear hub shifting system)
  - 6. gear (11-gear hub shifting system)
2. Move the crank slightly.
3. Align the two markings on the rear wheel hub exactly with one another by turning the adjusting screw on the twist grip (under the handlebar) in a clockwise or anti-clockwise direction.

## 13.4 Hybrid shifting system

### 13.4.1 Basics

In the case of models with a hybrid shifting system (dual drive), bikes are equipped with a combination of hub and derailleur gears.

The hub gear replaces the function of the front sprockets within the derailleur.

→ As a result, please refer to the sections "Derailleur" and "Hub switching" for information on safety, maintenance and servicing of the hybrid shifting components.

### 13.4.2 Operating the hybrid shifting system

The hybrid shifting system's control unit consists of:

- Shift lever (shifts the hub shifting system) and
- Rotating handle (shifts the derailleur gear).

→ Move the shift lever to the

- left position on uphill stretches,
- middle position on flat stretches,
- right position on descents.

→ Turn the rotating handle

- forward to shift to a higher gear,
- backward to shift to a lower gear.

### 13.4.3 Adjusting the hybrid shifting system

→ Contact a bicycle dealer for adjustments to the hybrid shifting system.

## 13.5 Continuously variable shifting system



### WARNING

Being unsure of how to use the gearshift system or experiencing problems with it may distract you from the traffic situation.

#### **Risk of accident and injury!**

- ▶ Familiarise yourself with the gearshift system before riding in traffic on the road.
  - ▶ Stop if you experience problems in operating the gearshift system, e.g. malfunctions.
- 

### NOTE

If used incorrectly, you can damage the gearshift system.

#### **Risk of damage!**

- ▶ Do not turn the pedals with too much force while shifting gear.
  - ▶ Do not pedal backwards while shifting gear.
  - ▶ Shift into the required gear in good time before uphill inclines.
- 

### 13.5.1 Basics

The continuously variable shifting system does not feature the classic gears but is infinitely adjustable.

The shifting system is located in the rear wheel hub.

The twist-grip shifter is used to shift up and down.

There are also models available with or without a coaster brake.

### 13.5.2 Operating the continuously variable shifting system

The display on the twist-grip shifter lets you read the gear which has been selected:

- “Flat” display: low pedal frequency for flat cycle routes
  - “Uphill” display: high pedal frequency for uphill cycle routes
- Turning the twist-grip shifter:
- backwards (against the direction of travel) to shift up (reduce pedal frequency; cycling becomes more difficult).
  - forwards (in the direction of travel) to shift down (increase the pedal frequency; cycling becomes easier).

### 13.5.3 Adjusting the variable shifting system

#### NOTE

The gearshift system can be damaged if adjusted incorrectly.

#### Risk of damage!

- ▶ Visit your bicycle dealer if you think that your gearshift system needs adjusting.

Only adjust the variable shifting system yourself if you have the necessary know-how and have already done so. Otherwise, have your bicycle dealer adjust it for you.

If the variable shifting system no longer functions correctly, adjust the position of the adjusting nut (see Fig. "Enviolo" adjustments).

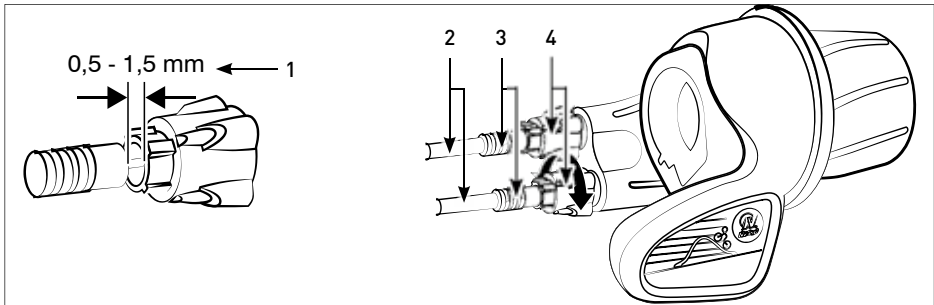

Fig. "Enviolo" adjustments

- |                      |                 |
|----------------------|-----------------|
| 1 Gap                | 3 Shaft         |
| 2 Outer cable casing | 4 Adjusting nut |

→ Carefully turn the adjusting nut

- in the clockwise direction if the gap is less than 0.5 mm.
- in the anti-clockwise direction if the gap is less than 1.5 mm.

→ Check if there is an improvement and repeat the previous step if necessary.

→ If you are unsure or continue to experience problems despite making an adjustment, please consult a bicycle dealer.

## 13.6 Continuously variable automatic gear shifting system

### 13.6.1 Basics

The continuously variable automatic gear shifting system does not have classic gears, instead it automatically makes adjustments depending on pedal frequency and speed or can be variably adjusted on a manual basis.

The shifting system is located in the rear wheel hub, and the control elements are on the handlebar (see Fig. "Operating elements of the continuously variable automatic gear shifting system" and "Operating modes").

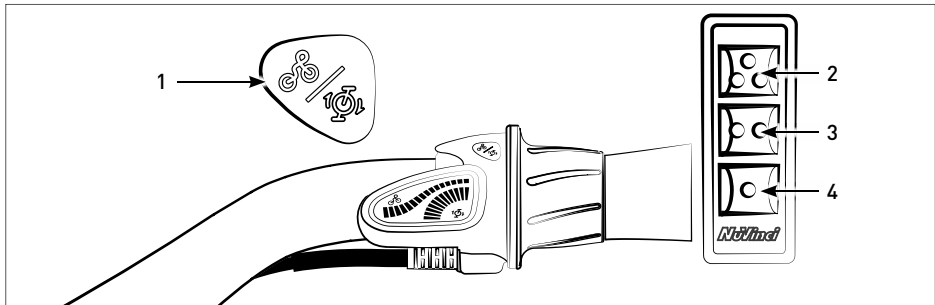

Fig. Operating elements of the continuously variable automatic gear shifting system

- |                        |                          |
|------------------------|--------------------------|
| 1 Mode button          | 3 Medium pedal frequency |
| 2 Fast pedal frequency | 4 Slow pedal frequency   |

### 13.6.2 Operating the continuously variable automatic gear shifting system

- Select the operating mode with the Mode button (see Fig. "Operating elements of the continuously variable automatic gear shifting system"):
  - Automatic mode: The shifting system automatically adjusts depending on the pedal frequency and speed.
  - Manual mode: variable shifting adjusted by the rider.
- Select the desired pedal frequency (fast/medium/slow) with the buttons (see Fig. "Operating elements of the continuously variable automatic gear shifting system").
- In manual mode, turn the twist-grip shifter:
  - backwards (against the direction of travel) to shift up (reduce pedal frequency; cycling becomes more difficult).
  - forwards (in the direction of travel) to shift down (increase the pedal frequency; cycling becomes easier).

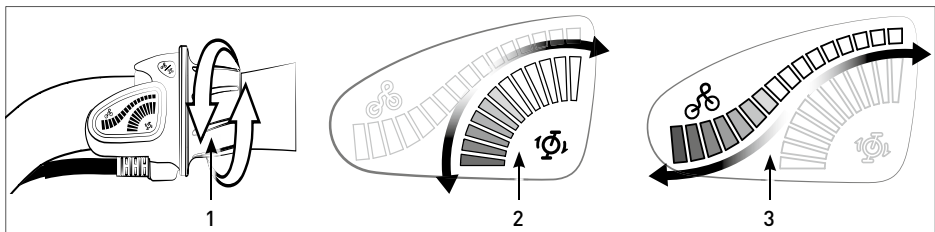

Fig. Operating modes

- |                      |             |          |
|----------------------|-------------|----------|
| 1 Twist-grip shifter | 2 Automatic | 3 Manual |
|----------------------|-------------|----------|

### 13.6.3 Adjusting the continuously variable automatic gear shifting system

#### NOTE

The gearshift system can be damaged if adjusted incorrectly.

#### **Risk of damage!**

- ▶ Visit your bicycle dealer if you think that your gearshift system needs adjusting or calibrating.
- 

Only adjust the variable shifting system yourself if you have the necessary know-how and have already done so. Otherwise, have your bicycle dealer adjust it for you.

If the automatic shifting system no longer functions correctly, calibrate the shifting system.

1. Lift the bicycle by the frame until the rear wheel can rotate freely.
2. Turn the rear wheel using the pedals and keep it moving while carrying out the following steps (approx. one turn per second).
3. Hold down the following buttons at the same time (see Fig. "Control elements of the continuously variable automatic gear shifting system"):
  - the Mode button,
  - "Fast pedal frequency" button,
  - "Slow pedal frequency" button.
4. Release the pressed buttons as soon as the shifting gear activates. At the same time, keep the rear wheel moving until you have shifted through all gears several times and the calibration process automatically stops.
5. If you are unsure, continue to experience problems with the shifting system or the calibration process cannot be carried out as previously described, please consult a bicycle dealer.

## 14 Lighting

### 14.1 Basics

Bicycles designed for road use must be fitted with the following lighting components:

- Headlamp,
- Tail lamp,
- Reflectors on the pedals,
- Side reflectors or light strips on the front and rear wheels,
- White front reflector,
- Red rear reflector (see Fig. "Lighting equipment").

→ Ensure that all lighting components meet national and regional requirements.

**i** In many countries, the specified lighting components must also be fitted to the bicycle and operational, even if the bicycle is only used on the roads during the day (during daylight hours).

**i** The LEDs in the headlamps and tail lamps cannot be replaced. When the LEDs reach the end of their useful life, the relevant lighting components must be replaced.

→ Have any faulty lamps replaced by a bicycle dealer.

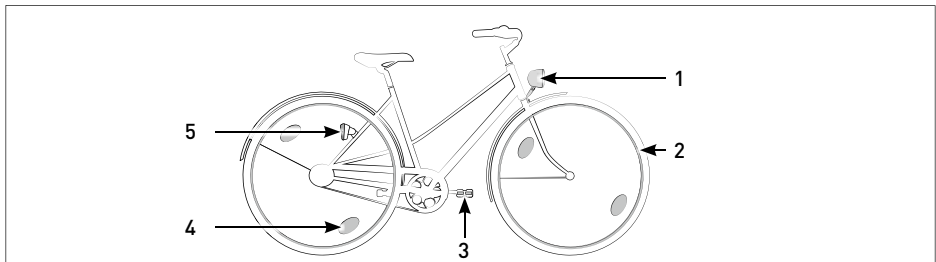

Fig. Lighting equipment (example)

- |  |                                  |
|--|----------------------------------|
| 1 Headlamp with rear reflector (white) | 4 Side reflector (yellow)        |
| 2 Light strip (white)                  | 5 Tail lamp with reflector (red) |
| 3 Reflector on pedal (yellow)          |                                  |



## 14.2 Operating lamps



### WARNING

If your lamps are not fitted or generate insufficient light, other road users may not be able to see you and you may not be able to see any unevenness or obstacles in the road.

#### Risk of accident and injury!

- ▶ Always switch on the lights in conditions of poor visibility (e.g. at dusk) and when it is dark.



### WARNING

Turning your lights on while riding may distract you from the road.

#### Risk of accident and injury!

- ▶ Always stop before turning on your lamps.

The bicycle may be fitted with a bottle dynamo or hub dynamo, depending on the model.

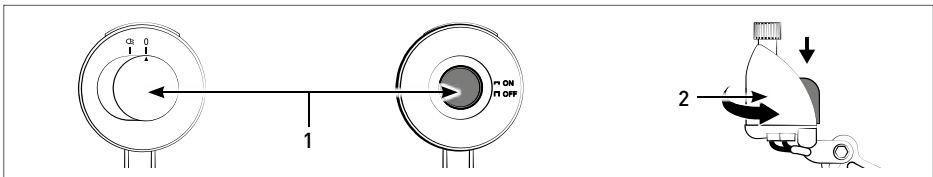

Fig. On/off switch (example)

1 On/off switch on headlamp

2 On/off switch on bottle dynamo

### 14.2.1 Bottle dynamo

If a bottle dynamo is fitted, the friction wheel rests against the tyre wall on the corresponding wheel and turns when the wheel rotates.

- Press down on the bottle dynamo from above so that the friction wheel rests on the tyre wall and the dynamo can be switched on (see Fig. "On/Off switch").
- Fold the bottle dynamo away from the relevant wheel until the friction wheel no longer makes contact with the tyre wall and the dynamo can be switched off.

Please note that dirt and water (e.g. from rain or snow) on the tyre wall may affect the function of the bottle dynamo.

- If you discover that the bottle dynamo no longer functions correctly when switched on, wipe down the tyre to remove any dirt or water.

## 14.2.2 Hub dynamo

The hub dynamo is located in the front wheel hub and is powered by the rotating front wheel. Since the hub dynamo is protected from dirt and water, weather conditions (e.g. rain and snow) have no effect on its function.

- Set the on/off switch on the back of the headlamp to "ON"/"1"/"☞" to switch on the light (see Fig. "On/Off switch").
- Set the on/off switch to "OFF"/"0" to switch off the light.

## 14.3 Adjusting the light



### WARNING

If the light range is set incorrectly, you may dazzle oncoming road users.

### Risk of accident!

- Regularly check whether the light range is set correctly.

### 14.3.1 Aligning the bracket

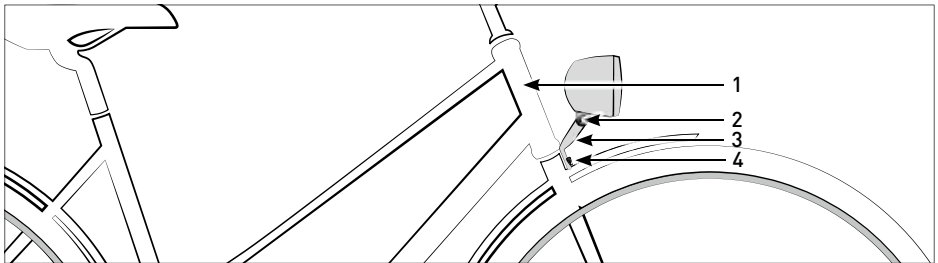

Fig. Adjusting screws

- |                      |           |
|----------------------|-----------|
| 1 Steering head tube | 3 Bracket |
| 2 Screw 2            | 4 Screw 1 |

The bracket must be aligned with the head tube.

1. Turn screw 1 anticlockwise a few times to loosen (see fig. "Adjusting screws").
2. Adjust the bracket so that it is aligned with the head tube.
3. Firmly attach the bracket by turning screw 1 clockwise to tighten.

### 14.3.2 Aligning the headlamp

The headlamp must be aligned in such a way that the emitted light beam reaches half the height of the headlamp at a distance of 5 m (see Fig. "Light range").

1. Switch on the headlamp to check the direction of the emitted light beam.
2. Turn screw 2 anticlockwise a few times to loosen (see fig. "Adjusting screws").
3. Tilt the headlamp forwards or backwards to align it correctly as described above.
4. Firmly attach the headlamp by turning screw 2 clockwise to tighten.
5. If you cannot align the headlamp, have the headlamp adjusted by a bicycle dealer.

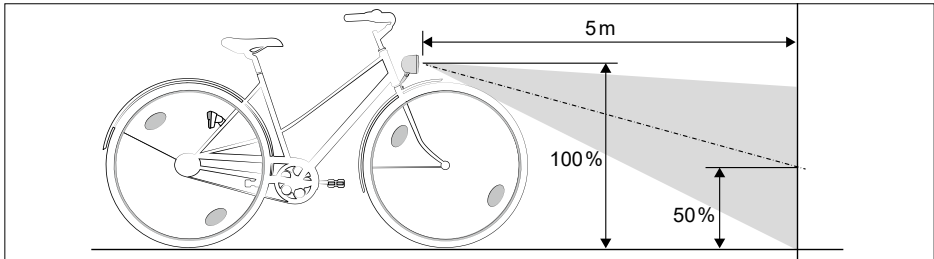

Fig. Light range

# 15 Wheels and tyres

## 15.1 Basics

The front and rear wheels each consist of a hub, spokes, rim and tyre around the circumference of the rim with or without an inner tube inserted.

On models with an inner tube, the rim is fitted with a rim tape to protect the inner tube from the rim base and spoke nipples.

During use, the weight of the rider and unevenness on the road place a heavy strain on the front and rear wheels.

- After breaking in your bicycle (after cycling 300 km, 15 hours of use or 3 months at the latest, whichever occurs first), have a bicycle dealer inspect the front and rear wheels and re-centre them, if required.
- After breaking in your bicycle, check the front and rear wheels regularly for damage and correct alignment.

### 15.1.1 Rims and spokes



#### **WARNING**

If the front or rear wheels wobble or do not rotate concentrically, this will affect riding safety and may cause the rim brakes to lock up.

#### **Risk of accident and injury!**

- ▶ If the front and rear wheels wobble or do not rotate concentrically, have them aligned by a bicycle dealer.
- 

If the spokes are tightened incorrectly or unevenly, this may affect the concentricity of the front or rear wheel. A loose spoke nipple or riding at speed over obstacles such as a kerb edge, for example, may affect the tension of individual spokes.

If individual spokes are tensioned incorrectly or damaged, the relevant wheel no longer rotates concentrically and wobbles, destabilising the rim and potentially causing it to break.

### 15.1.2 Wear limit

The rims on some models have recesses that allow you to determine how worn they are.

- Run your fingernail or a toothpick over the recess.
  - If you cannot or can only just feel the recess, do not use the bicycle. The rim must be replaced by a bicycle dealer.

## 15.2 Adjustments

### 15.2.1 Checking and adjusting spokes

- Ensure that the tension of the spokes is identical by carefully pressing two individual spokes together.
- If you discover that individual spokes have loosened, have a bicycle dealer tighten the spokes.

### 15.2.2 Checking the wear limit or replacing the rim

- Check the rims for cracks and damage.
- If the rims are made from composite material, have a bicycle dealer assess how worn they are.
- Have damaged rims replaced immediately. Consult a bicycle dealer.

Invisible damage can occur, particularly when double wall rims or rims made of composite material or aluminium are used.

## 16 Tyres and valves

### 16.1 Basics



#### CAUTION

Dirty or missing reflectors will make it more difficult for other road users to see you.

#### **Risk of accident and injury!**

- ▶ Keep your reflectors clean and replace missing or worn reflectors immediately.
- 



#### CAUTION

Damaged tyres may burst while you are riding.

#### **Risk of accident and injury!**

- ▶ Regularly check whether your tyres are damaged or heavily worn.
- 

#### NOTE

If the size of the tyres fitted to your bicycle is different to that of the original tyres, components may be damaged.

#### **Risk of damage!**

- ▶ If you have any questions or are unsure about the tyre size, consult a bicycle dealer.
- 

Different tyre sizes are fitted, depending on the intended use of a bicycle.

The tyre size is specified on the tyre wall in millimetres or inches.

- Millimetre specification: Width–inner diameter, e.g. 52–559.
  - When inflated, the tyre is 52 mm wide and the inner diameter is 559 mm.
- Inch specification: Inner diameter × width, e.g. 26" × 2.35".
  - When inflated, the tyre is 2.35" wide and the inner diameter is 26".

Tyres and rims do not form a single airtight unit and so the air is retained inside the tyre by an inner tube that is filled via the valve.

Tubular tyres and UST tubeless tyres are the only exception here.

- Make sure that the tyres do not have cracks or damage caused by foreign objects.
- Check the tread wear and make sure that the tyres are not too heavily worn.
- If the tyres are cracked or damaged, or the tread is very worn, consult a bicycle dealer.

### 16.1.1 Valve types

- Before purchasing a bicycle pump, consult a bicycle dealer to ensure that the valve connector or adapter on the pump is compatible with your valve.

The valve types listed below (incl. instructions for use) are used on bicycle inner tubes as standard:

- Presta valve (Sclaverand): Secured by a tappet inside the valve.
  1. To open the valve, turn the knurled screw anti-clockwise as far as it can go.
  2. Attach a compatible valve connector or adapter to the valve to inflate the tyre.
  3. Push down the knurled screw (valve connector or adapter not resting on the valve) to release air.
  4. To close the valve, turn the knurled screw clockwise as far as it can go.
- Express valve (Dunlop): Secured with cap nut.
  1. Turn the top knurled nut anti-clockwise to release air from the tyre.
  2. If you wish to change the valve insert, unscrew the top knurled nut completely.
  3. To close the valve, turn the top knurled nut clockwise as far as it can go.

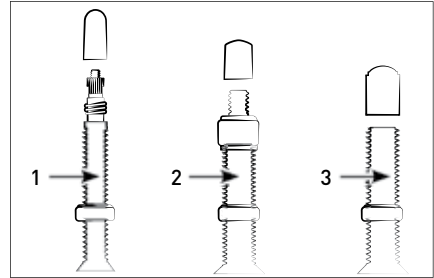

Fig. Valve types (example)

- 1 Presta valve (Sclaverand)
- 2 Express valve (Dunlop)
- 3 Schrader valve

- Schrader valve: Secured by a tappet inside the valve.
  - Push down the valve tappet (into the valve) to release air from the tyre.

### 16.1.2 Tyre inflation pressure



#### WARNING

If the tyre pressure is too high, the inner tube may burst or the rim may break while you are riding. If the tyre pressure is too low, the inner tube may be damaged.

#### Risk of accident and injury!

- ▶ Observe the maximum and minimum tyre pressure specifications.
- ▶ Use a bicycle pump with a pressure gauge.

Observe the maximum tyre inflation pressure defined by the lower of the two values specified on the rim or tyre wall.

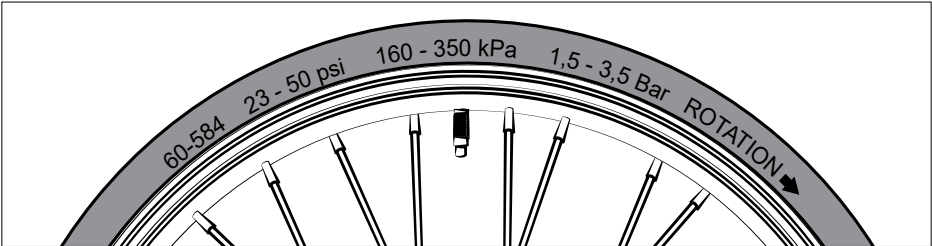

Fig. Imprint on the tyre wall (example)

A tyre inflation pressure corresponding to the specified **lower limit** is suitable for:

- Lighter riders,
- riding over uneven surfaces,
- riding with greater suspension comfort and a higher roll resistance.

A tyre inflation pressure corresponding to the specified **upper limit** is suitable for:

- Heavier riders,
- riding over even surfaces,
- riding with lower suspension comfort and a lower roll resistance.

- Regularly check whether the tyre inflation pressure is within the specified range and adapted perfectly to the rider and intended use.
- Observe the minimum and maximum tyre inflation pressure specifications.
- Fill the tyre with air
  - at least up to the specified lower limit but
  - not more than the specified upper limit.
- Use a bicycle pump with a pressure gauge to monitor the tyre pressure during the inflation process.

### 16.2 Adjustments

The tyre pressure influences the roll resistance and suspension of the bicycle.

1. Make sure your bicycle pump has a valve connector or adapter that is compatible with your valve.
2. Remove the protective valve from the valve.
3. Check the tyre pressure using a pressure gauge or a bicycle pump fitted with a pressure gauge.
4. Increase or reduce the tyre pressure as required by inflating or releasing air from the tyre.
5. Close off the valve using the protective cap you removed previously.
6. After adjusting the tyre pressure, ensure that the lower knurled nut on the valve is seated correctly and securely. If necessary, securely tighten the knurled nut by turning it clockwise towards the rim.



## 17 Other components

### 17.1 Handlebar

#### 17.1.1 Basics

The handlebar is an essential element for controlling the direction of the bicycle and incorporates operating elements such as the brake lever.

A handlebar stem with outer clamping or inner clamping will be fitted to your bicycle, depending on the model.

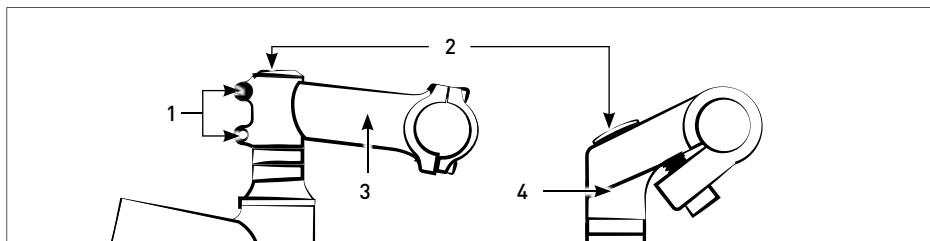

Fig. Handlebar stems

4 Screws

6 Handlebar stem with outer clamping

5 Cap

7 Handlebar stem with inner clamping

On some models, the angle of the handlebar stem can also be adjusted.

→ If you wish to adjust the angle of the handlebar on your model of bicycle and have related questions, please consult a bicycle dealer.

#### 17.1.2 Using the handlebar

→ When riding, hold the handlebar with your hands closed around the handlebar grips. The wrists should not be bent and your seating position should be comfortable for the duration of your journey.

#### 17.1.3 Adjustments: Handlebar height



### WARNING

Incorrectly performed adjustments may affect the function and safety of the bicycle components.

#### **Risk of accident and injury!**

- ▶ Observe the torque values.
- ▶ Observe the minimum insertion depth of the handlebar stem.

##### 17.1.3.1 Handlebar stem with outer clamping

If your bicycle has a handlebar stem with an outer clamping, adjusting the handlebar height requires specialist know-how.

→ In this case, have the handlebar height adjusted by a bicycle dealer.

### 17.1.3.2 Handlebar stem with inner clamping

1. Remove the cap from the top of the handlebar stem with inner clamping (see Fig. 'Handlebar stems', right).
2. Turn the internal screw one to two revolutions in an anti-clockwise direction.
3. Set the handlebar to the desired height by sliding the handlebar stem with inner clamping up or down. If the marking on the handlebar stem with inner clamping is visible, you have set the handlebar too high (see Fig. 'Handlebar stem with inner clamping').
4. Turn the internal screw clockwise and tighten to secure the handlebar in position. Observe the relevant torque values.
5. Attach the cap you removed previously back onto the handlebar stem with inner clamping.

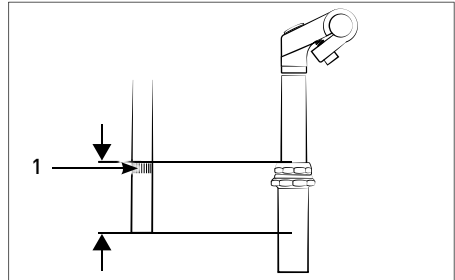

Fig. Handlebar stem with inner clamping  
8 Marking

### 17.1.4 Adjustments: Handlebar position

#### 17.1.4.1 Handlebar stem with outer clamping

#### NOTE

If you adjust the handlebar stem with outer clamping incorrectly, the steering head bearing may be damaged.

#### Risk of damage!

- Tighten the top screw on the handlebar stem with outer clamping until the steering head bearing is free of play but the bearing and handlebar can move freely at the same time.

1. Remove the cap from the top of the handlebar stem with outer clamping (see Fig. 'Handlebar stems', left).
2. Turn the top screw half a revolution in an anti-clockwise direction.
3. Loosen both screws on the shaft clamping in an anti-clockwise direction until you are able to turn the handlebar against the front wheel (see Fig. 'Head tube').



The following section describes how to adjust the steering head tube.

4. Turn the top-side screw in small increments (maximum one eighth of a revolution) in a clockwise direction.
5. Turn the screw clockwise and tighten to secure the steering head bearing in position free of play.
6. Press and hold the hand brake for the front wheel and attempt to push the bicycle back and forth to determine whether the steering head bearing is secure and free of play.
7. Lift the bicycle by the frame and tilt the frame to one side:
  - The front wheel must be able to rotate in this position as well as move to the left and right by itself. The steering head bearing is adjusted correctly if it is secured without play and the front wheel can rotate as well as move to the left and right by itself.

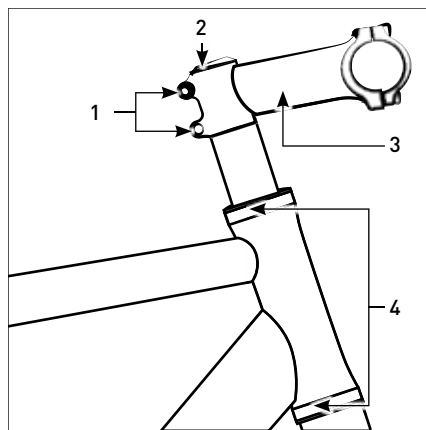

Fig. Steering head tube

- |                  |                         |
|------------------|-------------------------|
| 1 Screws         | 4 Steering head bearing |
| 2 Cap            |                         |
| 3 Handlebar stem |                         |

8. Turn the handlebar to an angle of 90° in relation to the front wheel (see Fig. 'Handlebar position').
9. Turn the two screws on the handlebar stem clockwise and tighten to secure the handlebar in position. Observe the relevant torque values.
10. Attach the cap back onto the handlebar stem with outer clamping.

#### 17.1.4.2 Handlebar stem with inner clamping

1. Remove the cap from the top of the handlebar stem with inner clamping (see Fig. 'Handlebar stems', right).
2. Turn the top screw half a revolution in an anti-clockwise direction.
3. Turn the handlebar to an angle of 90° in relation to the front wheel (see Fig. 'Handlebar position').
4. Turn the internal screw clockwise and tighten to secure the handlebar in position. Observe the relevant torque values.
5. Attach the cap you removed previously back onto the handlebar stem with inner clamping.

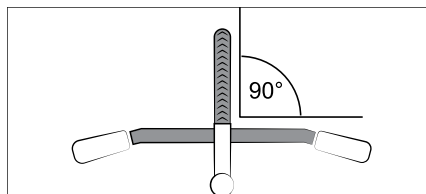

Fig. Handlebar position

### 17.1.5 Adjusting the steering head bearing

You will need the following tools to adjust the steering head bearing:

- 2x open-ended spanner/headset spanner (size depends on model)

Adjust the steering head bearing as follows:

1. Turn the lock nut anticlockwise to loosen it.
2. Turn the bearing shell clockwise and tighten. The steering head bearing must be free of play.
3. Press and hold the hand brake for the front wheel and attempt to push the bicycle back and forth to determine whether the steering head bearing is secure and free of play.
4. Lift the bicycle by the frame and tilt the frame to one side:
  - The front wheel must be able to rotate in this position as well as move to the left and right by itself. The steering head bearing is adjusted correctly if it is secured without play and the front wheel can rotate as well as move to the left and right by itself.
5. Hold the bearing shell firmly with one hand, then turn the lock nut clockwise and tighten to secure. Observe the relevant torque values.
6. Check the position of the handlebar: If necessary, turn the handlebar to an angle of 90° in relation to the front wheel (see Fig. 'Handlebar position').

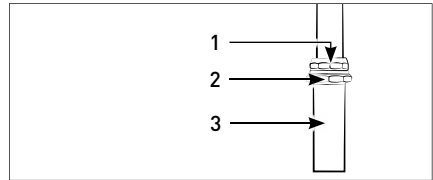

Fig. Steering head bearing

- |                 |                      |
|-----------------|----------------------|
| 1 Lock nut      | 3 Steering head tube |
| 2 Bearing shell |                      |

### 17.1.6 Racing bike handlebars

With racing bikes, the use of an aerodynamic handlebar extension kit can have a negative impact on the rider's reactions in relation to the bike's steering and braking characteristics.

## 17.2 Saddle

### 17.2.1 Basics

The saddle is used as a seat by the rider.

The intended use, personal preferences and physical attributes of the rider should be taken into consideration when choosing a saddle shape.

### 17.2.2 Adjusting the saddle

When the saddle is in the perfect position, riders should be able to assume a comfortable seating position, easily reach all operating elements on the handlebar and put their feet on the ground to support themselves.

## 17.2.2.1 Saddle height

**WARNING**

If the saddle height is adjusted incorrectly, it may affect the function and safety of the seatpost.

**Risk of accident and injury!**

► Observe the minimum insertion depth of the seatpost.

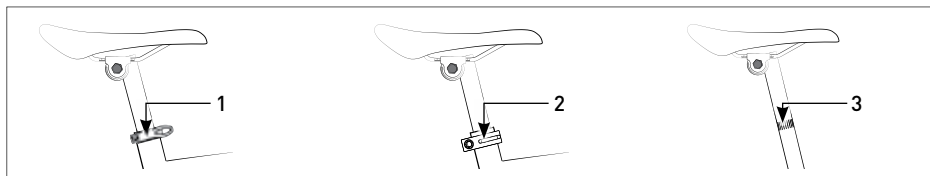

Fig. Seatpost clamp

1 Quick-release

2 Clamping screw

3 Marking

1. Hold the saddle in position with one hand.
2. Use the other hand to loosen the seatpost clamp as follows:
  - Open the quick-release (1) [see section "Quick-releases" on page 94].
  - Turn the clamping screw (2) on the seatpost clamp in an anti-clockwise direction [see Fig. 'Seatpost clamp'].
3. Slide the saddle up or down. Please remember that the mark (3) on the seatpost must not be visible [see Fig. 'Seatpost clamp'].
4. Position the saddle in a straight line with the frame.
5. Secure in position as follows:
  - Lock the quick-release. Remember that the quick-release lever must rest fully against the seat tube.
  - Turn the screw on the seatpost clamp in a clockwise direction and tighten. Observe the relevant torque values.
6. Make sure that the seatpost is secured in position by sitting on the saddle and bobbing up and down.
7. Make sure that the saddle is secured in position by applying slight pressure in an attempt to turn it.
  - If the saddle is not fixed in position, adjust the quick-release [see section "Quick-releases" on page 94].



Some models are fitted with a height-adjustable seatpost that can be adjusted within a 100 mm range.

1. Press and hold the button of the relevant operating element on the handlebar.
2. Pull the saddle upwards or push down on the saddle to lower it.
3. Release the button to secure the saddle in position.
4. If necessary, also adjust the saddle height using the seatpost clamp.

### 17.2.2.2 Saddle position

On some models, the saddle angle and distance of the saddle in relation to the handlebar can be adjusted.

1. Depending on the model, loosen the screw or screws on the seatpost between one and two revolutions in an anticlockwise direction (see Fig. 'Saddle clamp').
2. Align the saddle by pushing it into the correct position.  
On models with multiple screws, you must turn the loosened screws in opposite directions to adjust the saddle angle.
3. Turn the screw/screws on the seatpost clockwise and tighten to secure the seatpost in position. Observe the relevant torque values.
4. Make sure that the saddle is secured in position by applying slight pressure in an attempt to move it.  
→ If you are unsure or cannot secure the saddle firmly in position, please consult a bicycle dealer.

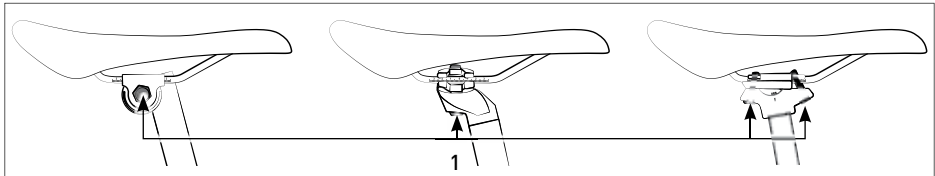

Fig. Saddle clamp

1 Screw

## 17.3 Pedals

### 17.3.1 Basics

The pedals are fixed to the cranks. The rider turns the pedals with their feet to propel the bicycle forwards.

Depending on the bike model, the bike is equipped with folding pedals, roadster pedals or clipless pedals.

The use of toeclips and clipless pedals in particular takes practice. With toeclips, we recommend that you use cycling shoes and set the tightening strap only once you have mastered the art of getting into and out of the toeclips.

Clipless pedals should only be used with special shoes which click into the clipless pedals. Ask a bicycle dealer to explain how they work.

### 17.3.2 Using the pedals

→ Tread on the pedals (pedalling) to turn the chain or belt and set the bicycle in motion.

### 17.3.3 Fitting pedals

→ When fitting the pedals, remember that the right pedal has a right-hand thread and the left pedal has a left-hand thread. Secure both pedals in position by screwing them into the respective crank in the direction of travel and remove both pedals by unscrewing them against the direction of travel.

## 17.4 Luggage rack

### 17.4.1 Basics

#### NOTE

Fitting a luggage rack incorrectly may damage bicycle components.

#### Risk of damage!

► Have your luggage rack fitted by a bicycle dealer.

The luggage rack is designed to transport lightweight baggage during your journey. Your bicycle will be fitted with either a luggage rack with a clamping bracket, a luggage rack with lashing straps or a luggage rack system, depending on the model.

- Do not modify the luggage rack as it may affect the stability or overall function of the bicycle.
- Regularly check that the luggage rack is properly secured.
- If you intend to fit a luggage rack to your bicycle or change your existing luggage rack, always consult a bicycle dealer first.
- If you are fitting a luggage rack for the first time or changing the luggage rack on your bicycle, always use luggage racks that meet the provisions outlined in DIN EN ISO 11243.
- Consult a bicycle dealer for more information on fitting a luggage rack.
- Ask a bicycle dealer to explain the special characteristics of luggage rack systems.
- Only load the luggage rack according to the manufacturer's information on loading your rack correctly.

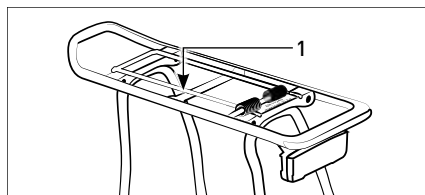

Fig. Luggage rack system

1 Clamping bracket

#### 17.4.1.1 Maximum load

#### NOTE

Overloading the luggage rack may damage bicycle components.

#### Risk of damage!

► When loading the luggage rack, take into consideration the maximum load of the luggage rack and the maximum total weight of the bicycle.

Maximum load of the luggage rack

- Rear luggage rack: 25 kg
- Front luggage rack: 12 kg

Depending on the model, the maximum load of some front luggage carriers may be 7 kg.

- Observe the maximum load specification printed on the luggage carrier (see Fig.: “Maximum load of some front luggage racks”).

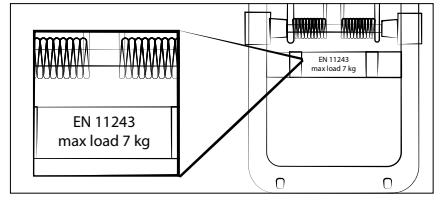

Fig. Maximum load of some front luggage racks

### 17.4.2 Using your luggage carrier



#### **WARNING**

Loading your bicycle incorrectly may affect the functions and safety of the bicycle.

#### **Risk of accident and injury!**

- ▶ Do not attach items of luggage (bags or similar) to the handlebar.
- ▶ Secure your luggage to the luggage carrier to prevent it from slipping or falling off.
- ▶ Always use undamaged lashing straps or equipment.
- ▶ Use proper bicycle bags from specialist retail outlets.
- ▶ Keep in mind that the payload may alter the behaviour of the bicycle.
- ▶ Position the luggage with the centre of gravity in the middle.



#### **CAUTION**

If lashing straps or clamping brackets are released suddenly, your fingers may be trapped or you may be struck by rebounding straps.

#### **Risk of injury!**

- ▶ Handle lashing straps and clamping brackets with care and hold securely when fastening and unfastening the load.

## 17.5 Luggage

- Please note that luggage can only be safely carried on a luggage rack.
- When loading your bicycle, make sure that the reflectors and lights remain clearly visible.
- While riding, keep in mind that your bicycle is carrying extra weight and may behave differently. You can expect longer braking distances and different steering behaviour.
- Secure the luggage to the luggage carrier using lashing straps or similar equipment to prevent it from slipping or falling off.
- Position heavy luggage with the centre of gravity at the lowest point possible, e.g. in panniers.



- Always make sure that the lashing straps or ropes used to secure loads cannot become caught in moving parts such as the rotating rear wheel or the crank.

## 17.6 Bell

### 17.6.1 Basics

A standard bicycle bell is usually a bright sounding metal bell that you can use to alert other road users and pedestrians of your presence.

- If your bell does not make a clearly audible sound, have it replaced by a bicycle dealer.
- Position the bell on the handlebar so that you can easily reach it without taking your hand off the handlebar grip.

### 17.6.2 Operating the bell

- Press and then release the bell button to produce a sound.

### 17.6.3 Adjusting the bell

- Position the bell on the handlebar so that you can easily reach it without taking your hand off the handlebar grip.

## 17.7 Kickstand

### 17.7.1 Basics

You can use the kickstand to park the bicycle upright when not in use.

### 17.7.2 Operating the kickstand

- When you wish to use your bicycle, hold it steady and lift up the kickstand using your foot, for example.
- When you wish to park your bicycle upright, hold it steady and push down the kickstand.
- Displace the weight of the bicycle so that the kickstand holds it in position.
- Once you are sure that the bicycle is standing steadily and will not fall over, you can let go.
- When you park your bicycle, protect it from theft and unauthorised use using a suitable lock.

### 17.7.3 Adjusting the kickstand

- Some models of kickstand can be adjusted.
- Adjust the kickstand if it no longer functions properly.
- If you are unsure of how to adjust the kickstand or experience problems when doing so, please consult a bicycle dealer.

### 17.8 Frame lock

Your bicycle may be equipped with a frame lock, depending on the model.

The frame lock does not offer adequate protection against theft.

Attach the bicycle to a stationary object such as a bicycle stand.

#### 17.8.1 Closing the frame lock

1. Insert the key into the lock and turn it to open the lock.
2. Push the lever down all the way. The lock engages.  
Keep in mind that the lock bolt must pass between the spokes (see Fig.: "Frame lock").
3. Remove the key from the lock.

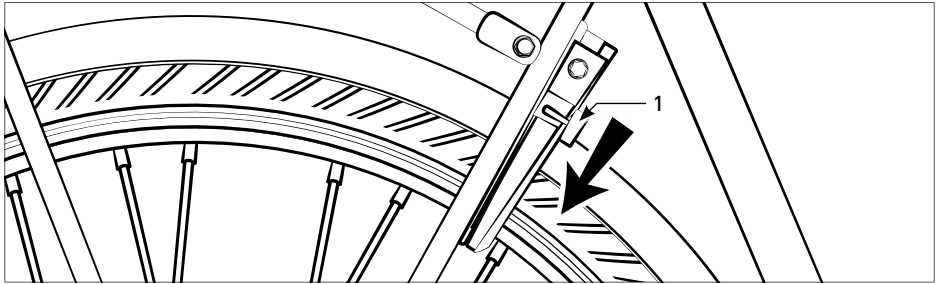

Fig. Frame lock

1 Grip

#### 17.8.2 Opening the frame lock

1. Insert the key into the lock and turn it.  
The lock is unlocked.
2. Push the lever all the way up to open the lock.
3. Remove the key from the lock.

## 17.9 Suspension

A suspension system adapted to the body weight of the driver and the intended use increases riding comfort and safety on uneven cycle routes. Individually adjusting the suspension requires specialist know-how and possibly the replacement of suspension components. If you are unfamiliar with or unsure of how to adjust the suspension, please consult a bicycle dealer.



### WARNING

If the suspension is adjusted incorrectly, it may affect the road holding of the bicycle, depending on the road conditions.

#### **Risk of accident and injury!**

- ▶ Have a bicycle dealer restore the suspension to its initial set-up.
- 



### WARNING

The components of the suspension system are under tension. If you improperly handle the coil-sprung seatpost, suspension fork or chainstay frame damper, they may uncontrollably disengage.

#### **Risk of accident and injury!**

- ▶ Always have the coil-sprung seatpost, suspension fork and chainstay frame damper removed and repaired by a bicycle dealer.
- 

### NOTE

An incorrectly adjusted suspension system may reduce riding comfort and the components may be damaged.

#### **Risk of damage!**

- ▶ If the suspension makes unusual noises or does not absorb bumps on the road during use, have it checked by a bicycle dealer.
- 

### 17.9.1 Suspension fork

#### 17.9.1.1 Basics

The suspension fork helps the front wheel absorb bumps and unevenness on the road.

- Keep the sliding surfaces on the suspension components and seals free of dirt.
  - Immediately remove any dirt using a clean cloth with a dab of oil applied, if required.
- After cleaning, apply a small quantity of lubricant to the sliding surfaces, e.g. multi-purpose oil. If necessary, consult a bicycle dealer for advice on suitable lubricants and care products.

- After lubricating, push down on the suspension five times so that the suspension fork is pushed into the mount, and remove any excess lubricant using a clean cloth.
- If the suspension makes unusual noises during use or you cannot feel any resistance when compressing the suspension, contact a bicycle dealer.

### 17.9.1.2 Sag

Sag refers to the compression of the suspension by the body weight of the rider. The sag should be 15-30 % of the total fork travel, depending on the model.

Sag influences the spring tension, but not the stiffness of the suspension.

If the sag has been set correctly, the suspension should only compress a few millimetres when the rider sits on the saddle.

Individually adjusting the sag requires specialist know-how, in particular if the system incorporates several suspension elements.



It may make sense to have a bicycle dealer replace the built-in spring with a harder or softer spring in order to optimally adjust the sag.

### 17.9.1.3 Lock-out

The “lock-out” function can lock the suspension fork and reduce rocking or plunging of the suspension with extreme force, for example, while you are riding.

### 17.9.1.4 Traction and compression stage

Adjusting the traction and compression stage influences the absorption and response characteristics of the suspension. The ratio between the traction stage and compression stage is crucial here, which is why only the traction stage can be adjusted on some models. The ratio between the traction stage and compression stage is adapted according to the road conditions and optimises contact between the ground and the wheels.

### 17.9.1.5 Operation

The model of the suspension fork determines how the suspension fork is operated.

If the suspension fork installed on your model has different or additional operating options, please refer to the relevant manufacturer documentation or consult a bicycle dealer.

### 17.9.1.6 Lock-out

#### **NOTE**

Using the lock-out function increases component wear.

#### **Risk of damage!**

- Only use the lock-out function if it will have a positive effect on the ride quality.
-

**i** Some models of suspension fork can not only be operated, but also adjusted.

Depending on the model, the operating element for the lock-out comes in the shape of a rotary knob at the top of the suspension fork or a remote control on the handlebar (see Fig. "Operation of lock-out").

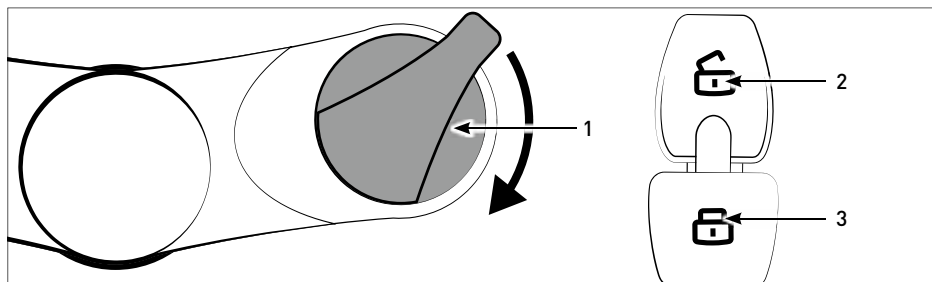

Fig. Operation of lock-out (example)

1 Rotary knob

2 Release button

3 Locking button

- Lock the suspension fork by turning the rotary knob clockwise one quarter of a turn or pressing the locking button.
- Unlock the suspension fork by turning the rotary knob anti-clockwise one quarter of a turn or pressing the release button.

**i** On uneven roads, the suspension can still be compressed up to 15 mm, even though the lock is active.

### 17.9.1.7 Adjusting a coil-sprung suspension

1. Remove the dust covers from all damper rods in a vertical direction.
2. Increase the preload by turning the rotary knob at the damper rod to "+" using a coin (see Fig. "Spring preload").
3. Reduce the preload by turning the rotary knob at the damper rod to "-" using a coin (see Fig. "Spring preload").
4. Make sure that the spring preload setting is the same on both sides.
5. If you are unsure of how to adjust the suspension or experience problems when doing so, please consult a bicycle dealer.

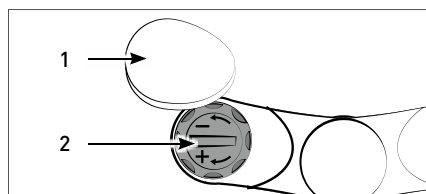

Fig. Spring preload

1 Dust cover

2 Rotary knob

### 17.9.1.8 Adjusting an air-sprung suspension

#### NOTE

Suspension components may be damaged if the damper rods are set incorrectly.

#### Risk of damage!

► Have a bicycle dealer adjust the air-sprung damping rods.

Adjusting the air-sprung suspension requires specialist know-how.

- If you are unfamiliar or unsure of how to adjust a suspension system, please consult a bicycle dealer.
- Use a suitable bicycle pump to adjust the air-sprung suspension.
- Read the manufacturer's documentation for more information on permitted air pressures.

### 17.9.1.9 Suspension fork travel

Reduce the fork travel as follows:

1. Press and hold the "Push" button (see Fig. "Fork travel").
2. Push down on the handlebar so that the suspension fork is pushed into the damper rod.  
The further you push the suspension fork into the damper rod, the shorter the fork travel will be.
3. Release the "Push" button to fix the setting.

Extend the fork travel as follows:

1. Press and hold the "Push" button (see Fig. "Fork travel").
2. Fix the front wheel and pull the handlebar upwards so that the suspension fork slides out of the mount.  
The further you pull the suspension fork from the mount, the longer the fork travel will be.
3. Release the "Push" button to fix the setting.

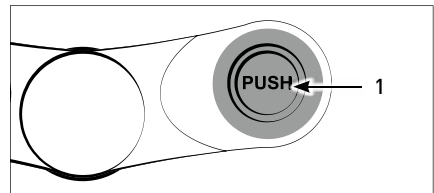

Fig. Fork travel  
1 "Push" button

## 17.9.2 Chainstay frame damper

A chainstay frame damper adapted to the body weight of the rider and the intended use increases riding comfort and safety on uneven cycle routes.

Individually adjusting the chainstay frame damper requires specialist know-how and possibly the replacement of suspension components.

- If you are unfamiliar or unsure of how to adjust the chainstay frame damper, please consult a bicycle dealer.
- If necessary, use the additional manufacturer documentation provided for the chainstay frame damper to find out how to adjust the chainstay frame damper.

### 17.9.2.1 Basics

The chainstay frame damper helps the rear wheel absorb bumps and unevenness on the road. The chainstay frame damper is located in the centre of the bicycle frame.

- Keep the sliding surfaces on the suspension components and joints free of dirt.
  - Immediately remove any dirt using a clean cloth with a dab of oil applied, if required.
- After cleaning, apply a small quantity of lubricant to the sliding surfaces, e.g. multi-purpose oil. If necessary, consult a bicycle dealer for advice on suitable lubricants and care products.
  - After lubricating, push the saddle down five times so that the chainstay frame damper is pushed into the mount and remove any excess lubricant using a clean cloth.
- If the suspension makes unusual noises during use or you cannot feel any resistance when compressing the suspension, contact a bicycle dealer.

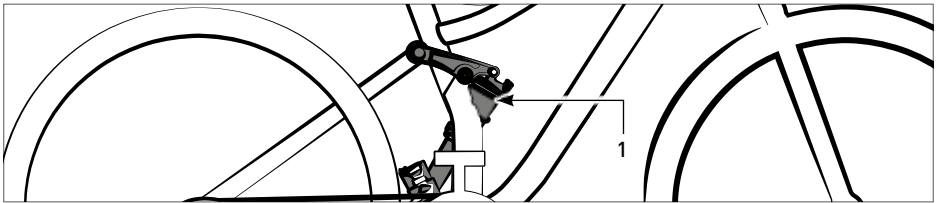

Fig. Chainstay frame damper

1 Damper

### 17.9.2.2 Adjustments

Adjusting the chainstay frame damper requires specialist know-how.

- If you are unfamiliar or unsure of how to adjust a chainstay frame damper, please consult a bicycle dealer.

### 17.9.3 Coil-sprung seatpost

A coil-sprung seatpost adapted to the body weight of the driver and the intended use increases riding comfort and safety on uneven cycle routes.

Individually adjusting the coil-sprung seatpost requires specialist know-how.

→ If you are unfamiliar or unsure of how to adjust the coil-sprung seatpost, please consult a bicycle dealer.

#### 17.9.3.1 Basics

The coil-sprung seatpost helps the saddle absorb bumps and unevenness on the road.

→ Keep the sliding surfaces on the suspension components and joints free of dirt.

→ Immediately remove any dirt using a clean cloth with a dab of oil applied, if required.

→ After cleaning, apply a small quantity of lubricant to the sliding surfaces, e.g. multi-purpose oil.

→ If necessary, consult a bicycle dealer for advice on suitable lubricants and care products.

→ After lubricating, push down on the saddle five times so that the seatpost is pushed into the mount, and remove any excess lubricant using a clean cloth.

→ If the suspension makes unusual noises during use or you cannot feel any resistance when compressing the suspension, contact a bicycle dealer.

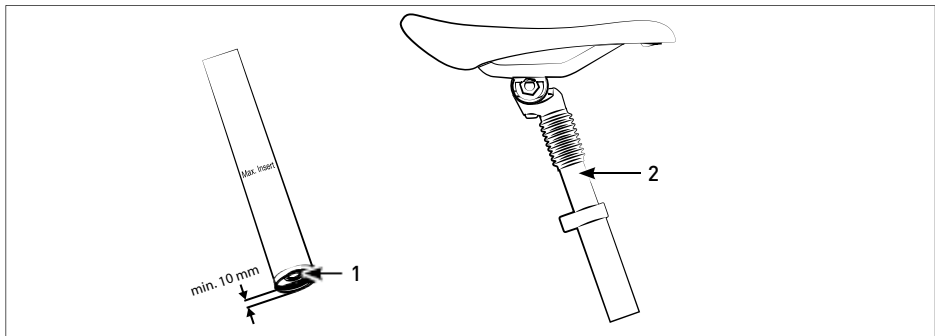

Fig. Adjusting the coil-sprung seatpost

1 Adjusting screw

2 Coil-sprung seatpost



### 17.9.3.2 Adjustments

Adjusting the coil-sprung seatpost requires specialist know-how.

→ If you are unfamiliar or unsure of how to adjust a coil-sprung seatpost, please consult a bicycle dealer.

If you intend to adjust the coil-sprung seatpost yourself, proceed as follows:

1. Remove the coil-sprung seatpost from the seat tube (see section "Adjusting the saddle" on page 80).
2. Turn the bottom adjusting screw in the seatpost
  - clockwise to increase the spring stiffness.
  - anti-clockwise to decrease the spring stiffness.
3. When adjusting the support, please note that a minimum of 10 mm of the adjusting screw must remain inside the coil-sprung seatpost.
4. If you are unsure of how to adjust the coil-sprung seatpost or experience problems when doing so, please consult a bicycle dealer.

### 17.10 Quick-releases

#### 17.10.1 Basics

Quick-releases are designed for quickly removing, installing and adjusting bicycle components without having to use tools.

The following components may be fitted with a quick-release:

- Axles (quick-release axles): Securing front or rear wheel
  - Seatpost clamp: Securing the seatpost
- Check whether the quick-release makes unusual noises when opened or closed.  
→ Remove any dirt from the quick-release using a clean cloth.

The removal and installation of the front and rear wheel require specialist know-how.

- Only remove or install the front or rear wheel using the quick-release lever if you have adequate specialist know-how.

#### 17.10.2 Operating quick-releases



#### **WARNING**

If the quick-release axles or the quick-release on the seatpost are not properly locked, the wheels or calipers may become loose while cycling.

#### **Risk of accident and injury!**

- ▶ If you do not have the necessary knowledge or tools, have the bicycle dealer install/deinstall the quick-release axles.
  - ▶ Before setting off, make sure that the quick-release lever is locked with adequate pretension and is resting against the component/frame.
- 



#### **CAUTION**

If you operate the quick-releases incorrectly, you may pinch your fingers or other parts of the body.

#### **Risk of accident and injury!**

- ▶ Always handle quick-releases with care.
- 

##### 17.10.2.1 Opening quick-releases

- To open the quick-release lever, pull it outwards away from the relevant frame element.

### 17.10.2.2 Locking quick-releases

- Lock the quick-release by pushing the quick-release lever towards the appropriate frame element until it rests against the seatpost (seat tube clamp) or fork (axle).
- If you notice that the relevant seatpost or quick-release axle is not fixed in position when the quick-release is closed, adjust the quick-release accordingly.

### 17.10.3 Adjusting quick-releases

1. To open the quick-release lever, pull it outwards away from the relevant frame element.
  2. Screw in the adjusting screw and the axle nut clockwise one quarter of a revolution.
  3. Lock the quick-release by pushing down the quick-release lever fully against the frame element.
  4. Check whether the seatpost or the front or rear wheel are secured in position with the quick-release.
  5. If necessary, repeat steps 1–3 until the seatpost or front or rear wheel are secured in position when the quick-release is locked.
- If the quick-release locks into position too easily (with minimal/no effort), adjust the pretension.
  - If you are unsure of how to adjust the quick-release or experience problems when doing so, please consult a bicycle dealer.

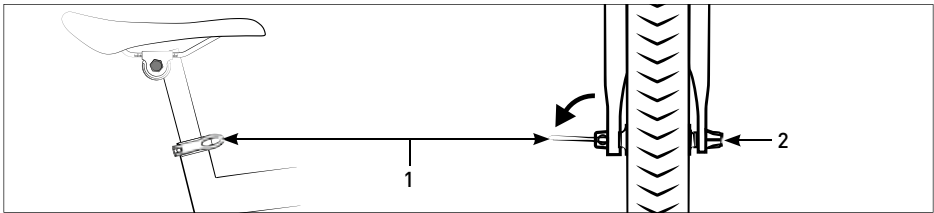

Fig. Adjusting quick-releases

1 Quick-release lever

2 Axle nut

### 18 Storage and disposal

This section contains information on how to store and dispose of your bicycle safely.

#### 18.1 Storing the bicycle

If you do not intend to use your bicycle for a prolonged period, proceed with storage as described below:

- Store the bicycle in a dry room protected from freezing temperatures and significant fluctuations in temperature.
- Hang a stored bicycle by the frame to prevent the tyres from deforming.
- Clean the bicycle before placing it into storage.
- If the bicycle is fitted with a derailleur gear, change to the small chain wheel at the front and the smallest sprocket at the rear to relieve the cables as much as possible.

 After taking the bicycle from storage, shift the chain wheel and the sprocket cassette to a gear combination suitable for the intended use before using the bicycle again [see section “Gear combinations” on page 55].

#### 18.2 Cleaning the bicycle

In the interests of your own safety, please note the following safety information:



#### **CAUTION**

Moving parts on the bicycle can trap or pinch body parts.

#### **Risk of injury!**

- ▶ Secure moving parts, if possible.
  - ▶ Wear protective gloves.
- 

#### **NOTE**

Using unsuitable cleaning products can result in material damage.

#### **Risk of damage!**

- ▶ Do not use aggressive cleaning products.
  - ▶ Do not use sharp, angular or metal cleaning tools.
  - ▶ Do not use powerful water jets or high-pressure cleaners.
- 

You will need the following items to clean the bicycle:

- Clean cloths
- Mild, tepid soap suds
- Sponge or soft brush
- Cleaning products and preserving agents

- If necessary, consult a bicycle dealer for advice on suitable cleaning products and preserving agents.
- Clean the bicycle regularly, even if only slightly soiled.
- Wipe down all surfaces and components using a sponge moistened with mild soap suds.
- After cleaning, wipe all surfaces and components dry.
- Preserve all painted and metal surfaces on the frame at least every 6 months.
- Colours may fade due to UV irradiation and other environmental conditions.
- If the bicycle is fitted with rim brakes, do not preserve the rims. Likewise, if the bicycle is fitted with disc brakes, do not preserve the brake discs.
- Read and follow the instructions for cleaning individual components included in the manufacturer's information.

## 18.3 Disposal



If you own a pedelec, read the original operating instructions for information on disposal.

### 18.3.1 Disposing of packaging

- Dispose of the packaging according to material type. Dispose of card and cardboard in your paper container and films in your plastic recyclables container.

### 18.3.2 Disposing of lubricants and care products

- Dispose of lubricants, cleaning agents and care products in line with environmental regulations.

Do not dispose of these items together with the domestic waste, into sewer systems or into the environment. Read the information on the packaging. Dispose of lubricants, cleaning agents and care products at a collection point for hazardous waste.

### 18.3.3 Disposing of tyres and inner tubes

Tyres and inner tubes do not qualify as residual or domestic waste.

- Dispose of inner tubes and tyres at a recycling centre or collection point run by the local city council or municipality.

### 18.3.4 Disposing of the bicycle

- Dispose of the bicycle at a recycling centre or collection point run by the local city council or municipality.

# 19 Warranty and guarantee terms and conditions

## 19.1 General

The statutory warranty provisions in the country where the bicycle was purchased apply. Warranty claims must be asserted against the bicycle dealer from whom the bicycle was purchased.

In order for warranty and guarantee claims to be asserted, proof of purchase for the relevant bicycle must be provided. The completed handover certificate and completed bike passport must be presented.

The customer must also register in the “Extended guarantee” section on our website [www.corrattec.com](http://www.corrattec.com). The two-year statutory warranty only applies if registration or inspections are not carried out.

## 19.2 Guarantee terms and conditions

In addition to the statutory warranty, the company iko Sportartikelhandels GmbH provides an extended guarantee for corrattec’s frame and fork. The guarantee is limited to the original purchaser and is non-transferable.

The guarantee is valid for:

- the aluminium frame: six years
- full-suspension frame: six years
- the carbon frame: six years

Product defects identified during the warranty period are rectified free of charge through replacement or repair of the relevant parts. All guarantee services are only provided by a bicycle dealer selected by the company iko Sportartikelhandels GmbH.

The guarantee only applies to bicycles that have been assembled by a bicycle dealer authorised by the company iko Sportartikelhandels GmbH and which are made roadworthy.

Warranty and guarantee claims cannot be asserted

- for damage resulting from use of the bicycle for a purpose other than described in the instruction manual.
- for damage resulting from the use of unauthorised replacement parts.
- for damage attributed to a force majeure, accident, improper use, incorrectly performed repairs, wear or inadequate care and maintenance.
- for damage resulting from use of the bicycle for competitive racing.

If a frame is replaced as part of a guarantee claim, the guarantee shall become void and no further guarantee claims can be asserted on the new frame.

## 20 Bike passport

Manufacturer/model \_\_\_\_\_  
 Type and design \_\_\_\_\_  
 Frame size \_\_\_\_\_  
 Frame design \_\_\_\_\_  
 Frame number \_\_\_\_\_  
 Suspension fork manufacturer \_\_\_\_\_  
 Suspension fork model \_\_\_\_\_  
 Serial number \_\_\_\_\_  
 Gear system (manufacturer, type) \_\_\_\_\_  
 Brake (front, manufacturer, type) \_\_\_\_\_  
 Brake (rear, manufacturer, type) \_\_\_\_\_  
 Wheel/tyre size \_\_\_\_\_  
 Permitted total weight \_\_\_\_\_  
 Purchase date \_\_\_\_\_

### Brake lever assignment

Right brake lever  Front wheel brake  Rear wheel brake  
 Left brake lever  Front wheel brake  Rear wheel brake  
 Luggage carrier  front  rear  retrofittable  
 not suitable for luggage carriers  
 Child seat  Installation permitted  
 Installation not permitted  
 Trailer coupling  Installation permitted  
 Installation not permitted  
 Other \_\_\_\_\_

Stamp

Bicycle dealer's signature

## 21 Handover certificate

We wish you a safe journey on your new bicycle!

### Acknowledgement

- I have received verbal instructions on carrying out care and maintenance as well as on product information. I have received an original user manual in printed form.
- I am aware that the vendor's warranty obligations only apply to product defects. The warranty does not cover wear damage resulting from normal use of the product.
- I have thoroughly inspected the entire product. The delivered product was complete and showed no sign of obvious damage.
- I hereby confirm that the bicycle dealer checked the safety of the bike and made all necessary adjustments before handing over the bike.

### Comments

---

---

---

---

---

---

---

---

Place, date

Purchaser's signature



## 22 Inspection report

### 1. Inspection

After approx. 200 km or 2 months

Date

Stamp and  
dealer's signature

### 2. Inspection

After approx. 1000 km or 1 year

Date

Stamp and  
dealer's signature

### 3. Inspection

After approx. 2000 km or 2 years

Date

Stamp and  
dealer's signature

### 4. Inspection

After approx. 3000 km or 3 years

Date

Stamp and  
dealer's signature

### 5. Inspection

After approx. 4000 km or 4 years

Date

Stamp and  
dealer's signature

### 6. Inspection

After approx. 5000 km or 5 years

Date

Stamp and  
dealer's signature

# **SUPPLEMENTARY INSTRUCTION MANUAL**

## **CHILDREN'S BIKE**

**DIN EN ISO 8098 / DIN EN 82079-1**

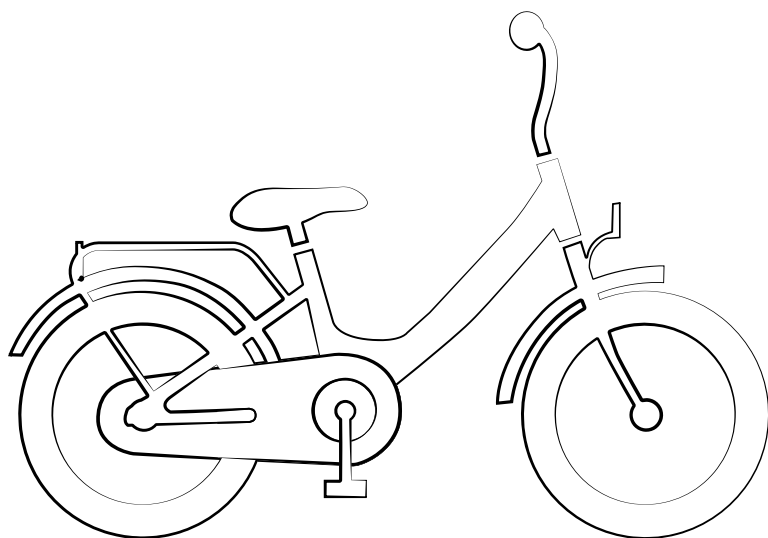

## 23 General information



This supplementary instruction manual is intended specifically for the parents or guardians of children. It must be observed in conjunction with the "Bicycle Instruction Manual". Before your child uses the children's bike, read the "Bicycle Instruction Manual" carefully all the way through, in particular the safety information and instructions on using and operating the bicycle.



### **WARNING**

A lack of knowledge of road use can result in accidents.

#### **Risk of accident!**

- ▶ Explain the rules of road conduct to your child.
  - ▶ Encourage your child to adopt a defensive, cautious approach on the road.
  - ▶ Only allow your child to use the bicycle on the road once he or she has understood the rules of road conduct.
  - ▶ Always make sure your child is accompanied by a person with parental authority when cycling on roads.
- 



### **WARNING**

A lack of knowledge on how to use the children's bike can result in accidents.

#### **Risk of accident!**

- ▶ Explain how to operate the children's bike to your child.
  - ▶ Always make sure your child can operate the children's bike safely before allowing him or her to cycle on the road.
- 



### **WARNING**

Overloading the components may cause them to break.

#### **Risk of accident and injury!**

- ▶ Explain to your child that only one person can ride the bicycle at any one time. Persons must not be transported on the luggage rack, top tube or handlebar.
  - ▶ Make sure that the maximum permitted total weight of the children's bike is not exceeded.
-



## WARNING

Children may not have adequate knowledge or skills.

### **Risk of accident and injury!**

- ▶ Do not allow children with impaired physical, sensory or mental capabilities or a lack of experience and specialist know-how to use the children's bike.
  - ▶ Do not allow children to carry out care and maintenance tasks.
  - ▶ Do not allow small children to play with packaging material, in particular the packaging film. Children may become caught in the material and suffocate or cut themselves.
- 

- Read the instruction manual all the way through and explain all of the contents to your child.
- Practice cycling on the road with your child and only allow them to cycle unsupervised when they are able to take responsibility for their own actions.
- Regularly check your child's seating position and have a bicycle dealer make adjustments, if necessary.
  - Observe the information on the minimum insertion depth of the saddle and handlebar (see section "Adjusting the saddle" on page 80 of the Bicycle User Manual).

## 24 Safety information



## WARNING

Incorrect or improper use of the children's bike poses a significant accident risk.

### **Risk of accident!**

- ▶ Only allow your child to use a children's bike on the road if the equipment fitted meets the road traffic regulations applicable in your country.
  - ▶ Always make sure your child uses the children's bike in line with national and regional road traffic regulations.
  - ▶ Explain the national and regional regulations relating to the use of pavements, cycle paths and roads to your child.
-

**WARNING**

Slippery or dirty roads impair the road holding and increase the braking distance of your bicycle.

**Risk of accident and injury!**

- ▶ Make sure your child adapts the speed of his or her bicycle to the weather and road conditions.
- 

**WARNING**

Make sure your child always wears bright clothing so that they are clearly visible to other road users.

**Risk of accident and injury!**

- ▶ Always make sure your child cycles on the road wearing bright clothing that is easy to notice, such as clothing with reflective elements.
- 

**WARNING**

Cycling without head protection poses a significant risk of injury.

**Risk of injury!**

- ▶ Make sure your child always wears a suitable adapted helmet when riding the children's bike.
  - ▶ Ask a bicycle dealer for advice on choosing a suitable helmet for your child.
  - ▶ Ask the bicycle dealer to show you how your child's helmet should be used.
- 

**WARNING**

Your child must pay attention to the road traffic at all times.

**Risk of accident and injury!**

- ▶ Explain to your child that he or she should not be distracted by other activities while riding, e.g. switching on a retrofitted lamp.
  - ▶ Forbid your child to operate mobile devices while riding, e.g. smartphones or MP3 players.
-



## WARNING

Attachments and incorrect accessories may impair the function of the children's bike.

### **Risk of accident and injury!**

- ▶ Always have any modifications to the children's bike carried out by a bicycle dealer.
  - ▶ Always make sure that fitted accessories meet the national traffic regulations applicable in your country.
  - ▶ Ask your bicycle dealer for information about suitable accessories.
- 



## WARNING

Improper use of the children's bike can cause the frame or fork to break.

### **Risk of accident and injury!**

- ▶ Instruct your child not to jump over ramps and mounds on the children's bike.
  - ▶ Instruct your child not to ride down slopes on the children's bike.
  - ▶ Instruct your child not to ride through deep water or near bodies of water on the children's bike.
  - ▶ Instruct your child not to ride their children's bike through terrain where it could become excessively dirty.
  - ▶ Instruct your child not to ride over steps, kerbs or other drops on the children's bike.
- 

## 25 Residual risks

Even if your child observes all the relevant safety information and warnings, use of the children's bike is subject to the following unforeseeable residual risks:

- Curiosity can distract children from the road.
- Children may misjudge the road-holding capability and speed of the bicycle as well as their own riding skills, for example.
- Other road users may behave incorrectly.
- Unforeseeable road conditions, such as black ice caused by freezing rain.
- Arbitrary material fatigue or material defects can cause the breakage or functional failure of components.

## 26 Proper use

The manufacturer or dealer does not accept liability for damage resulting from improper or incorrect use.

Improper use of the children's bike will void the warranty (see section "Warranty and guarantee terms and conditions" on page 98 of the Bicycle Instruction Manual).

The children's bike was designed to be used by one person for whom the seating position has been set accordingly (see Bicycle User Manual, Section "Seating position" on page 19). Carrying other persons on the bike, e.g. on the luggage carrier, is not allowed.

The maximum permitted total weight of the children's bike must not be exceeded.

Children's bikes which are not equipped for road use are intended exclusively for personal use. Before the children's bike can be ridden on the road, it must be fitted or upgraded with all the necessary equipment required to meet the relevant national and regional road traffic regulations.

The children's bike was not designed to withstand above-average loads, e.g. using the bicycle for races and competitions is considered improper (see Bicycle User Manual, Section "Warranty and guarantee terms and conditions" on page 98).

The children's bike is not designed for the installation of a child seat.

In order to use the children's bike properly, the rider must be aware of, understand and adhere to the relevant national and regional regulations.

The children's bike must meet all the relevant national and regional regulations in order to be used as intended (see Bicycle User Manual, Section "Road safety" on page 23).

Your child must always use the children's bike as described in this user manual. Any other use is considered improper and may lead to accidents, personal injury or property damage.

## 27 Basics

This section contains information on road use as well as general information on using the children's bike.

### 27.1 Information on road use

If the children's bike comes fitted with equipment that is not approved for road use, the following applies: If you intend for the children's bike to be used on the road, have the bicycle fitted with compliant components.

- Before your child makes his or her first journey, find out about the national and regional equipment regulations relating to children's bikes applicable in your country. For example, relating to:
  - Helmet requirements
  - Safety vest requirements
  - Brakes
  - Lights and reflectors
  - Bell
- Only allow your child to ride on the road if the equipment fitted to the bicycle meets the national and regional road traffic regulations applicable in your country.
- Before your child uses the children's bike on the road, have it upgraded with all the necessary equipment, if required.
- Explain to your child the national and regional regulations relating to equipment fitted to children's bikes.
- If in doubt, ask a bicycle dealer for advice.
- Find out about all the national and regional road traffic regulations applicable in your country. The regulations that usually apply to children and minors are different to those that apply to adults.
  - Explain the traffic regulations to your child as well as how he or she must behave when cycling on the road.
  - Explain to your child the national and regional regulations relating to the use of:
    - Pavements
    - Cycle paths
    - Roads
- Only allow your child to cycle on the road unsupervised if:
  - Permitted according to the national and regional regulations applicable in your country.
  - You are confident that your child is capable of doing so.
- Encourage your child to adopt a defensive, cautious approach on the road.
- Teach your child to cycle in such a way that they do not injure, endanger, obstruct or inconvenience other people.
- Make sure your child always wears a suitable adapted helmet when riding the children's bike. Ask a bicycle dealer for advice on choosing a suitable helmet.



Cycling proficiency courses for children are available in many regions. Course instructors adopt a light-hearted approach to teaching your child how to cycle and behave correctly on the road.

Laws and regulations can change at any time. Therefore, enquire regularly about the national and regional regulations applicable in your country and explain them to your child.



## 27.2 Rules for children up to 10 years of age in Germany

- Children up to 8 years of age must cycle on the pavement.
- Children up to 10 years of age are allowed to cycle on the pavement.
  - Explain the rules for pedestrians walking in traffic to your child.

## 27.3 Notes on brakes

The children's bike is fitted with a minimum of two brakes that act on the front and rear wheel independently of one another. One of the brakes or an additional brake may be a coaster brake.



### **WARNING**

Wet conditions can significantly alter the braking performance of rim brakes.

#### **Risk of accident and injury!**

- ▶ Have your child practise braking in wet conditions away from road traffic.
  - ▶ Instruct your child to cycle slowly in wet conditions.
- 

## 27.4 Before each ride

Before each ride, check the following points:

- Thoroughly check the children's bike for damage and excessive wear before your child uses the child's bike.
- Explain to your child that the children's bike must not be used if it is damaged.

## 27.5 Inspection instructions

Before each ride, check the following points:

- Check the condition of the frame and components.
  - All components are to be checked for deformations, cracks and changes in colour.
  - Check if the handlebar, pedals and saddle are securely and properly attached and adjusted (see Bicycle User Manual, Section "Basic adjustments" on page 28).
  - If your children's bike is equipped with a luggage carrier, check that the luggage carrier is securely and properly attached.
- Check that the brakes are working.
  - Activate the brake arm and coaster brake and listen for any unusual noises.
  - In order to ensure that the children's bike comes to a stop while cycling, check whether it is impossible to push the children's bike forward when one of the brakes is pulled, and if it is possible, that this can only be done when pushing very hard.
  - The brake pads must not grind when the brake arm is released.

- Check that the lights and bell are working.
  - Check whether the headlamp and rear lamp function correctly when switched on. To do this, turn the wheel with the dynamo or check the charge status of the batteries if the bike has been retrofitted with battery lighting.
  - Check whether you hear a clear sound when you ring the bell.

### 27.6 Before your first trip



#### **WARNING**

Distraction of the child due to unexpected behaviour of the children's bike, e.g. when braking.

#### **Risk of accident and injury!**

- ▶ Only let your child on the road with their children's bike if they know how the bicycle handles and they know how to operate it.
- 

The bicycle dealer carries out the complete assembly of the children's bike and individually adjusts the handlebar, saddle and brake arm for the child.

- When you pick up the children's bike, check whether your child can comfortably and safely ride the children's bike and whether all adjustments have been made for your child.
- Only have a bicycle dealer carry out adjustments.
  - If you make adjustments yourself, ask your bicycle dealer for information about the torque to use and use a torque key.
  - If you make adjustments yourself, thoroughly check the adjustments in a technically correct manner before letting your child use the bicycle.
- Before your child's first trip, get acquainted with the children's bike and tell your child how to operate it.
- Practise cycling with your child away from traffic so that they get used to how the bike handles.
- Have your child practise getting on and off the bike and safely braking with the bike.
  - Your child must be able to stand over the frame of the children's bike.
- Have your child practise pedalling standing up.
- Have your child practise braking at low speed, especially with a coaster brake (if any).
- Have your child practise emergency braking.
- Have your child practise signalling before turning and looking back over their shoulder.
- Only let your child ride the children's bike when they can take responsibility for it.

## 28 Stabilisers

Stabilisers are training wheels that provide a child with support while they are learning to ride a bicycle. They prevent the children's bike from tipping over.

- Assess whether your child needs stabilisers to help them learn to ride a bicycle.
- If your child needs stabilisers to learn to ride a bicycle, use the stabilisers that come supplied with the bike.
- If the bicycle does not come with stabilisers, please ask a bicycle dealer for advice on choosing and fitting suitable stabilisers.

### 28.1 Fitting stabilisers



#### **WARNING**

If the wrong stabilisers are fitted or the stabilisers are fitted incorrectly, they may cause a functional impairment, such as rear wheel failure.

#### **Risk of accident and injury!**

- ▶ If you do not have the necessary specialist know-how and tools to install the stabilisers, consult a bicycle dealer.

The children's bike may come with compatible stabilisers, depending on the model. If your child requires stabilisers, you should always use the stabilisers delivered with the bicycle.

Always fit the stabilisers with care to ensure they serve their purpose properly and safely.

- If the children's bike does not come with stabilisers, make sure any stabilisers you purchase are compatible with the bicycle. The bolts inserted at the rear wheel of the children's bike must be long enough to attach the stabilisers securely on both sides.
    - Your bicycle dealer will be glad to advise you on choosing suitable stabilisers.
  - Follow the stabiliser installation instructions provided by the manufacturer.
1. Unscrew the cap nuts from both ends of the axle in an anti-clockwise direction and remove them.
  2. Remove the attached washers from the axle.



Stabilisers often consist of several parts.

3. Assemble the stabilisers as described in the manufacturer's instructions.

4. Slide the first assembled stabiliser onto one end of the axle on the children's bike followed by the hub axle washer, then screw on the cap nut and tighten to the specified torque (see "Fig.: Fitting stabilisers").
5. Slide the second assembled stabiliser onto the other end of the axle on the children's bike followed by the hub axle washer, then screw on the cap nut and tighten to the specified torque (see "Fig.: Fitting stabilisers").
  - When tightening the cap nuts, make sure that the rear wheel is aligned with the frame and front wheel.
  - When tightening the cap nuts, make sure that the chain is still taut.

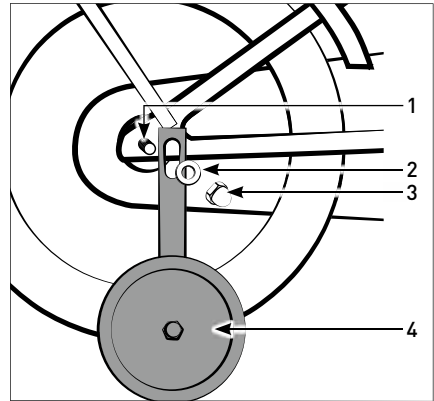

Fig. Fitting stabilisers

- |                   |              |
|-------------------|--------------|
| 1 Rear wheel axle | 3 Cap nut    |
| 2 Washer          | 4 Stabiliser |

The stabilisers can be adjusted in height.

- Check where the elongated holes are located on the stabilisers for this purpose. Follow the installation instructions provided by the manufacturer.

Both stabilisers should be the same distance from the ground. The stabilisers should not touch the ground when the children's bike is held upright.

## 28.2 Removing stabilisers

1. Unscrew the two cap nuts and remove them from the axle.
2. Remove the two washers and then the stabilisers from either end of the axle.
3. Slide the washers back onto the axle, screw on the cap nuts and tighten to the specified torque.
4. When tightening the cap nuts, make sure that the rear wheel is aligned with the frame and front wheel.
5. When tightening the cap nuts, make sure that the chain is still taut.

## 29 Publisher

iko Sportartikel Handels GmbH  
Kufsteiner Str. 72  
D-83064 Raubling  
www.corrattec.com

The bicycle weights provided are approximate values and may vary slightly due to production tolerances.

Pictures only for illustration purposes of colours. Please refer to the specification list for further information. Colours may deviate slightly due to production.

**Scan the following QR code with your smartphone in order to view the complete user manuals.**

**Or access them at:**  
**[www.corrattec.com/de/manuals/](http://www.corrattec.com/de/manuals/)**



### **Text, content and layout**

QIMA Testing Germany GmbH

Schleidenstrasse 1 | 22083 Hamburg (Germany)  
Tel. +49 (0) 40-600 202-0  
www.qima.com |

### © Copyright

Texts, pictures and information in this documentation are protected by copyright of the QIMA Testing Germany GmbH. The translation, reproduction, duplication or other commercial use of this documentation on electronic media, for example, in whole or in part is not permitted without prior written permission from the QIMA Testing Germany GmbH.

This original instruction manual for your Pedelec fulfills the requirements and scope of the standards DIN EN 4210 and DIN EN 82079-1.

Version Corrattec\_RAD\_01\_EN

***corrateg***  
*PASSION OF CYCLING*